

# Electronic Preselection Counter

## Two preselections BCP 48



# Operating Instructions

**BAMO MESURES**

22, Rue de la Voie des Bans - Z.I. de la Gare - 95100 ARGENTEUIL  
Tél : (+33) 01 30 25 83 20 - Web : [www.bamo.fr](http://www.bamo.fr)  
Fax : (+33) 01 34 10 16 05 - E-mail : [info@bamo.fr](mailto:info@bamo.fr)

Electronic Preselection Counter  
**BCP 48**

04-03-2004

289 M1 01 A

**MES**

**289**

# Contents

	Page
<b>1 Safety indications</b>	<b>2</b>
<b>2 Get to know your BCP 48</b>	<b>4</b>
2.1 Components	4
2.2 Block diagrams of the BCP 48	4
<b>3 Connection</b>	<b>5</b>
3.1 Supply voltage connection	6
3.2 Assignment of signal outputs „Relay contacts“	6
3.3 Assignment of signal outputs „electronic“	7
3.4 Assignment of signal inputs	7
3.4.1 Examples of connection	7
3.5 Encoder supply connection	8
3.6 Interface connection	8
<b>4 Operation</b>	<b>9</b>
<b>5 Programming</b>	<b>11</b>
5.1 Operating and preselection modes	17
5.2 Counting modes for principal counter and totalizer (Input Mode)	17
5.3 Output (Output Mode)	18
<b>6 Technical data</b>	<b>19</b>
6.1 Dimensions and cutout measures	19
6.2 Error messages	20
<b>7 Models / Ordering data</b>	<b>20</b>

## General information

Please find below the explanation to the symbols used in the following operating instructions.

### *Explanation of symbols*

- ➔ This symbol induces actions.
- This symbol refers to additional technical information.



---

This symbol is placed in front of text passages that have to be particularly observed to ensure the correct use of the BCP 48.0

---



---

This symbol is placed in front of text passages that supply further important information.

---

### *Italics*

Important terms are written in *italics* on the left for quick reference purposes.

## 1 Safety indications

The electronic counter, controller and monitor has been designed to the latest state of the art.

Use the instrument only

- in an absolutely correct technical state,
- for the intended purpose,
- being conscious of relevant safety and danger, and observe the operating instructions.

### *Intended purpose*

The instrument is to be used only indoors as built-in model for industrial processes and controls on production lines of the metal, wood, plastic, paper, glass and textile industries and similar; the overvoltage exerted on the terminals of the instrument must be limited to the voltages of category II.

Description of the overvoltage category under DIN VDE 0110, Part 2.

The instrument may only be operated in a correctly mounted state.

The instrument may only be operated as described under chapter „Technical data“.



---

The instrument may not be used in hazardous areas, for medical apparatus, nor for applications expressly declared under EN 61010. If the instrument is to be used to control machines or processes, where the machine could be damaged or the operator could be injured due to a breakdown of the instrument or to a failure in operation, then relevant safety precautions will need to be taken.

---

### *Organizational measures*

Make sure that your personnel has read and understood the operating instructions, especially the chapter "Safety indications".

In addition to the operating instructions, please make sure that generally applicable legal and other mandatory regulations relevant to accident prevention and environment protection are observed.

### *Be conscious of safety*

In the event of safety-relevant modifications (including those in the behavior of the instrument during operation), immediately stop operation of instrument.

*Installation* The installation may only be effected as described under the chapter „Connection“.  
During installation work, take care to cut off the power supply of the instrument.  
Installations may only be effected by a skilled expert.  
Prior to initial operation of the instrument, please control the voltage selection. Set the switch to the required AC voltage.  
During installation make sure that supply voltage and connection of the output contacts are provided from the same MAINS phase.  
Max. voltage 250 V Terminal - Terminal, Earth - Terminal.

*Initial operation* The instrument is ready for use after it has been correctly mounted and installed.

*Maintenance / Servicing /  
Trouble shooting* Cut off power supply of all connected machinery.  
These tasks may only be effected by a skilled expert. In case of unsuccessful trouble shooting, you must absolutely interrupt use of instrument and contact your dealer.

*Getting acquainted* After successful initial operation, get acquainted with the handling of your instrument by studying the chapter „Get to know your BCP 48“.

## 2 Get to know your BCP 48

### 2.1 Components

It comprises



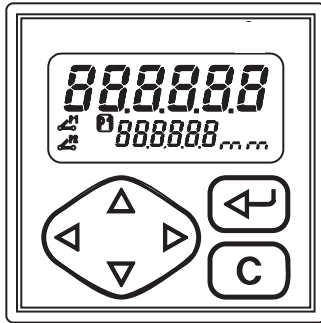



- a 6-digit preselection counter with 1 or 2 settings
- a 6-digit batch counter with 1 or without preselection
- an 8-digit totalizer.



#### LCD-Display

Current count  
 P1 Preselection 1  
 P2 Preselection 2  
 Control state of preselection P1  
 Control state of preselection P2  
 tot Totalizer  
 b Batch counter  
 Measuring units: mm, cm, dm, m, L

#### Control panel

-  Shift key for display of functions Confirmation key,
-  Reset
-  Key to select HIGHER decades
-  Key to select decades to the RIGHT
-  Key to select decades to the LEFT
-  Key to select LOWER decades

### 2.2 Block diagram

The block diagram shows the components of the NE134 together with its contacts and connections.

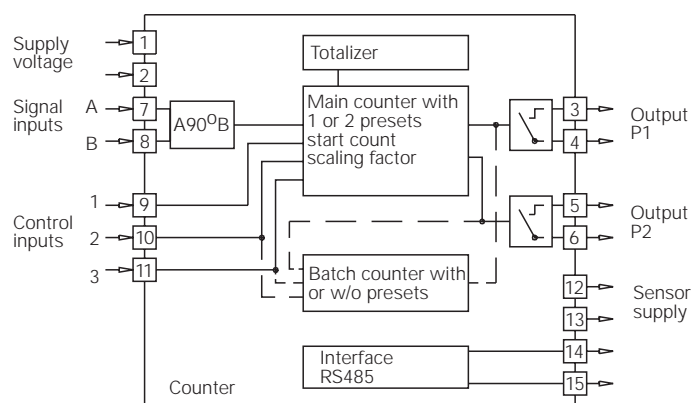

### 3 Connection

This chapter will explain how the contacts are assigned and give you some examples of connection. Under chapters 3.1 to 3.6, you will find actual tips and technical data for the various connections.

#### Assignment Model with relay outputs

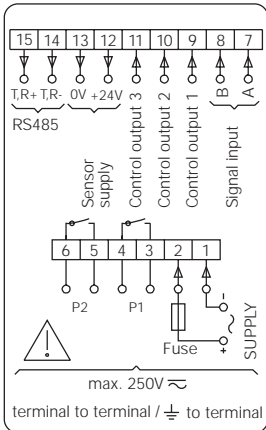

Contact	Function
1	Supply voltage
2	Supply voltage
3	Relay output P1
4	Relay output P1
5	Relay output P2
6	Relay output P2
7	Signal input Track A
8	Signal input Track B
9	Control input 1 (Principal counter Reset)
10	Control input 2 (Principal counter Stop)
11	Control input 3 (Totalizer Reset)
12	Encoder supply +10 ... 26 V
13	Encoder supply 0 V
14	Option RS485 (T,R-)
15	Option RS485 (T,R+)

#### Assignment Model with electronic outputs

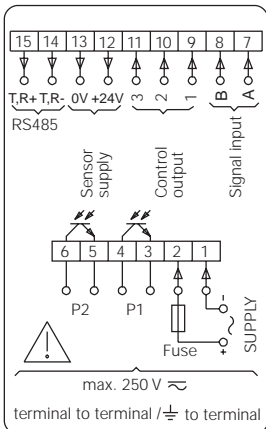

Contact	Function
1	Supply voltage
2	Supply voltage
3	Output P1
4	Output P1
5	Output P2
6	Output P2
7	Signal input Track A
8	Signal input Track B
9	Control input 1 (Principal counter Reset)
10	Control input 2 (Principal counter Stop)
11	Control input 3 (Totalizer Reset)
12	Encoder supply +10 ... 26 V
13	Encoder supply 0 V
14	Option RS485 (T, R-)
15	Option RS485 (T, R+)



Litz contact only by means of connector sleeves with insulating enclosures for reasons of shock protection according to EN 61010. Do not otherwise assign contacts that have been left unassigned ex factory. We recommend to screen all encoder terminal leads and to ground the shield on one side. Shields on both sides are recommended in case of RF interference or in case of equipotential bonding. The encoder leads should not be in the same phase winding as the MAINS supply and the output contact leads.

### 3.1 Supply voltage connection

*AC connection* It is possible to choose two different AC voltages by using the selector on the side. The respectively higher voltage (48 VAC or 230 VAC) is preset at the factory.

- ➔ Switch to the required AC voltage using the selector.
- ➔ Connect AC at the contacts 1 and 2 according to the NE134 terminal diagram.

Supply voltage	Recommended external protection
24 VAC ±10 % 50/60 Hz	M 400 mA
48 VAC ±10 % 50/60 Hz	M 200 mA
115 VAC ±10 %	50/60 Hz M 100 mA
230 VAC ±10 %	50/60 Hz M 50 mA

*DC connection* Connect interference-free supply voltage. Therefore, do not use the supply voltage for parallel supply of drives, contactors, electromagnetic valves, etc.  
➔ Connect DC according to the NE134 terminal diagram.

Supply range: 12 ... 30 VDC, max. 5 % residual ripple  
Recommended external protection: M 400 mA



Fire protection: Operate instrument on the MAINS with external fuse recommended on the rating plate. In case of disturbance, make sure that 8 A /150 VA (W) are never exceeded – as defined under EN 61010.

### 3.2 Assignment of signal outputs „Relay contacts“

Contact P2

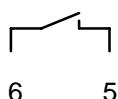

Contact P1

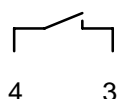

The signal outputs (contacts 3, 4 and 5, 6) are floating relay contacts. The signal outputs can be assigned as per the adjacent terminal diagram. The type of outputs, as momentary or latched signal, can be chosen in the programming lines 41 / 42. Their function, as normally open or closed, is selected in programming line 40.

Max. rating	Max. voltage	Max. current
150 VA / 30 W	250 V	1 A



The user must take care that, in case of disturbance, the contact rating of 8 A / 150 VA (W) is not exceeded. Internal spark suppression by means of zinc-oxide varistor (275 V). The output relays of the instrument (1 relay or several) may in total **switch 5 x per minute at the most. Admissible clicks** according to interference suppression standard EN 55011, EN 50081-2 for the industrial sector. In case of higher switching rate, the operator will be responsible to take care of local interference suppression in consideration of the contact rating.

### 3.3 Assignment of signal outputs „electronic“

Output P2

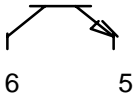

Output P1

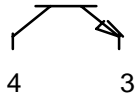

The electronic outputs (contacts 3, 4 and 5, 6) are optocoupler outputs. The signal outputs can be assigned as per the adjacent terminal diagram. The type of outputs, as momentary or latched signal, can be chosen in the programming lines 41/42. Their function, as normally open or closed, is selected in programming line 40.

Max. switching voltage	Max. swit. current	Max. residual voltage
+ 40 VDC	25 mA	at 25 mA < 1 V



The electronic outputs are not short-circuit-proof.

### 3.4 Assignment of signal inputs

*Choice of PNP or NPN*

The contacts 7 to 10 are comparator signal inputs. They can be triggered either by PNP or NPN encoders. The input logic as well as the operating threshold are correspondingly chosen in programming line 33. The contacts 7 (Track A) and 8 (Track B) are counting inputs for a counting range between 3 Hz, 25 Hz or 10 kHz. The counting rate is determined in programming lines 31 and 32. The contacts 9, 10 and 11 are 3 control inputs for Reset, Stop, Hold, Print, Keylock etc. The function of these control inputs is selected in the programming lines 34, 36 and 37. The minimum pulse duration of control input 1 can be switched in programming line 35 from 30 ms to 100 µs. For control inputs 2 and 3, 30 ms are generally valid.

Input resistance	Selectable operating threshold
ca. 3 kOhm	3 V and 6 V

#### 3.4.1 Examples of connection

Encoder	NE134 contact assignment	Programming
Contact	7 Track A 12 + 24 V	Counting rate: Line 31 to 1 = 25 Hz Line 31 to 2 = 3 Hz
Proximity switch PNP or NPN	7 Track A 12 + 24 V 13 0 V	Input logic: Line 33 to 0 = PNP Line 33 to 1 = NPN
Namur without explosion protection	7 Track A 13 0 V	Input logic: Line 33 to 1 = NPN
Incremental encoder	7 Track A 8 Track B 12 + 24 V 13 0 V	Counting mode: A 90° B (x1, x2, x4) Line 30 to 3, 4, 5 Counting rate: Line 31, 32 to 0 = 10 kHz



### 3.5 Encoder supply connection



Connect encoder supply for rotary encoder, proximity switch, etc. to the contacts 12 and 13. However, do not use encoder supply for unearthed inductors or capacitive loads.



The encoder supply is not short-circuit-proof.

Contact	Voltage	Max. admissible current
12	10 ... 26 VDC	60 mA
13	0 V	

### 3.6 Interface connection

The serial interface can perform the following functions:

- Retrieve data
- Program parameters.

Interface parameters are:

- Transmission speed (Baud rate),
- Parity bit,
- Number of stop bits,
- Address of controller for master.

The interface parameters can be set on the programming level (Lines 51 to 54).

#### RS485

Half-duplex transmission with the following features:

- Symmetrical
- 2 lines
- Multi-point connection – emitter and receiver (max. 32 units)
- Maximum distance of data transmission: 1500 m

→ Assign contacts 14 (T,R-) and 15 (T,R+) accordingly.

## 4 Operation

The following chapter will inform you on the operation of your NE134.

- The NE134 is automatically on the operator level after the supply voltage has been turned on.

On the operator level it is possible

- to read and, if necessary, clear the current count;
- to read and, if necessary, modify the preselections P1 and P2;
- to read and, if necessary, modify the preset start count;
- to read and, if necessary, clear the totalizer;
- to read and, if necessary clear the batch counter;
- to read and, if necessary, modify the scaling factor.

- It is possible to disable all operator parameters on the programming level (Lines 11-17).

### The keys and their function

*Parameter reading* Select the enabled parameters via the key  $\Delta$  or  $\nabla$ .  
The key  $\leftarrow$  allows to switch to the next operation parameter.  
For quick sweep, keep this key depressed.

*Resetting of counts* 1. Display count of respective parameter.  
2. Push  $\text{C}$ .

*Setting of parameters* 1. Display parameter.  
2. Push  $\triangleleft$  or  $\triangleright$  and select required decade; chosen decade position blinks.  
3. Push  $\Delta$  or  $\nabla$  and enter required value.  
To set further decades, repeat steps 2 and 3.  
4. Confirm the parameter entered with  $\leftarrow$ .  
Should no confirmation be given within 15 s, the previous setting will remain valid.

### Current count

The upper display indicates the current count.  
The lower display indicates preselection P2 or a parameter of your choice in programming line 27.

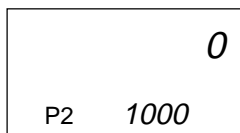

*Read* Read count and, for example, preselection P2.

*Clear* Push  $\text{C}$ .

### Preselection P1

*Read* Push  $\nabla$  or  $\leftarrow$ .

The preselection value P1 is displayed.  
The lower display indicates „P1“.

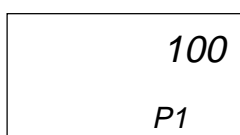

*Modify* Enter preselection P1 via the keys  $\triangleleft \triangleright \Delta \nabla$ .  
Push  $\leftarrow$ .

1000
P2

**Preselection P2**

*Read* Push ▽ or  $\leftarrow$ .

The preselection value P2 is displayed.  
The lower display indicates „P2“.

*Modify* Enter preselection P2 via the keys ◀ ▶ Δ ▽.  
Push  $\leftarrow$ .

0
SC

**Start count SC**

*Read* Push ▽ or  $\leftarrow$ .

The start count SC is displayed.  
The lower display indicates „SC“.

*Modify* Enter the start count SC via the keys ◀ ▶ Δ ▽.  
Push  $\leftarrow$ .

H	99	999999
	tot	tot

**Totalizer tot**

*Read* Push ▽ or  $\leftarrow$ .

The Totalizer tot is displayed.  
The lower display indicates „tot“.

If the value 999999 is exceeded, its display will be shown in two steps:  
First step: Display of the first 6 digits.  
Second step, marked by an H: Display of the 7<sup>th</sup> and 8<sup>th</sup> digits.  
Display of each value for ca. 3 seconds.

*Clear* Push  $\text{C}$ .

0
b

**Batch counter b**

*Read* Push ▽ or  $\leftarrow$ .

The batch counter b is displayed.  
The lower display indicates „b“.

*Clear* Push  $\text{C}$ .

1.0000
--------

**Scaling factor SF**

The scaling factor allows the display of fractions or multiples of the principal counter and totalizer.

Setting range: 0.0001 to 9999.99. Setting ex factory to 1.0000.

*Example* In the case of a length measurement by means of encoder and cyclometer, where the circumference of the cyclometer measures 200 mm and the encoder supplies 500 pulses per revolution, the measurement is to be displayed in mm.

The scaling factor is calculated as follows for this example:

$$\text{Scaling factor} = \frac{\text{Circumference}}{\text{Pulses}} = \frac{200}{500} = 0.4000$$

*Read* Push ▽ or  $\leftarrow$ .

The scaling factor SF is displayed.  
The lower display indicates „SF“.

*Modify* Enter the scaling factor via the keys ◀ ▶ Δ ▽.

The setting range from 0.0001 to 999.99 is attained by shifting the decimal point. Select the decimal point via ◀ and shift using Δ.

Push  $\leftarrow$ .



By pushing ▽ or  $\leftarrow$  again, the current count is re-displayed.

## 5 Programming

This chapter will inform you on how to program your NE134.

**Programming level** Operation parameters are set on the programming level.  
The programming level consists of 3 programming fields.  
Access is protected by a 4-digit code or via a control input.

**1<sup>st</sup> programming field** Here it is possible to select and modify all operation parameters. The operation parameters that are disabled for the operator are also displayed.

**2<sup>nd</sup> programming field** The individual operation parameters for operator access are disabled or enabled here.

**3<sup>rd</sup> programming field** All functions and values as well as interface parameters conditioned by the machinery are programmed here.

### The keys and their function

**Turn on programming** Push  $\Delta$  and  $\leftarrow$  simultaneously.  
„Code“ appears on the lower display.



---

No code number has yet been set at the factory, therefore it is possible to skip the code query by pushing  $\leftarrow$ .

The code is set on programming line 50.

After a code has been set, it will only be possible to switch to the programming level by entering the correct code.

---

**Enter code** Enter code via the keys  $\leftarrow \triangleright \Delta \nabla$ .  
Push  $\leftarrow$  to confirm.  
The instrument switches from the operator level to the programming level.

**Wrong code** If a wrong code has been entered, „Error“ is displayed as long as  $\leftarrow$  remains pushed.  
After 15 s the instrument switches automatically back to the operator level.

**Correct code unknown** If the correct code is not known, please return the counter to the supplier or effect reset to factory setting.

**Select programming lines** Select the programming line needed via the keys  $\nabla \Delta$ .  
This function can also be reached by pushing  $\leftarrow$ .  
The line number is displayed.

**Modify operation parameters** Select the decade to be changed via the keys  $\leftarrow \triangleright$ .  
The selected decade blinks.  
Enter the value by pushing the keys  $\Delta \nabla$ .  
Push  $\leftarrow$ .

**Leave programming** It is possible to shut down the programming at any time by pushing  $\Delta$  and  $\leftarrow$  simultaneously.

**Reset to factory setting** Turn on instrument and press the keys  $\leftarrow$  and  $\Delta$  simultaneously.  
All values already programmed are set back to the factory setting. 'ClrPro' briefly appears on the display.

**Programming field 1**

Here it is possible to select and modify all operation parameters. The operation parameters that are disabled for the operator are also displayed.

Line 1 

0
1    PC

**PC - Principal counter** (current count)

Line 2 

100
2    P1

**P1 - Preselection 1**

Line 3 

1000
3    P2

**P2 - Preselection 2**

Line 4 

0
4    SC

**SC - Start count**

Line 5 

0
5    tot

**tot - Totalizer**

Line 6 

0
6    b

**b - Batch counter**

Line 7 

1.0000
7    SF

**SF - Scaling factor**

- - - - -

The dash line indicates the end of the first programming field. Switch to programming field 2 by pushing ▾ or ↶.

## Programming field 2

The individual operation parameters for operator access are disabled or enabled here.

**StAt** appears on the upper display. The lower display indicates the line number and the abbreviation for the operation parameter. The status number is entered on the upper display.

**0** Free access

**1** Display only

**2** Disabled

### Meaning of the status numbers

It is possible to select, read and modify the operation parameter on the operator level.

It is possible to select and read the operation parameter on the operator level.

It is impossible to select the operation parameter on the operator level. Its corresponding function is however sustained.



Each factory setting is marked as such by \*.

Modify status

Enter corresponding status number via the keys ◀ ▶ △ ▽. Push .

Line 11

```

StAt  0
      11 PC
    
```

### PC - Principal counter

- 0 \* Free access
- 1 Display only
- 2 Disabled

Line 12

```

StAt  0
      12 P1
    
```

### P1 - Preselection 1

- 0 \* Free access
- 1 Display only
- 2 Disabled

Line 13

```

StAt  0
      13 P2
    
```

### P2 - Preselection 2

- 0 \* Free access
- 1 Display only
- 2 Disabled

Line 14

```

StAt  2
      14 SC
    
```

### SC - Start count

- 0 Free access
- 1 Display only
- 2 \* Disabled

Line 15

```

StAt  2
      15 tot
    
```

### tot - Totalizer

- 0 Free access
- 1 Display only
- 2 \* Disabled

Line 16

```

StAt  2
      16 b
    
```

### b - Batch counter

- 0 Free access
- 1 Display only
- 2 \* Disabled

Line 17

```

StAt  2
      17 SF
    
```

### SF - Scaling factor

- 0 Free access
- 1 Display only
- 2 \* Disabled

```

- - - - -
    
```

The dash line indicates the end of the second programming field. Switch to programming field 3 by pushing ▽ or .

### Programming field 3

All functions and values as well as interface parameters conditioned by the machinery are programmed here.



Each factory setting is marked as such by \*.

Line 21

21	0
----	---

#### Operating modes Principal counter

- 0 \* Adding, final signal at P2, reset to SC
- 1 Subtracting, final signal at SC. If programming with automatic reset (Line 23), it is effected at SC.
- 2 Subtracting, final signal at SC. if programming with automatic reset (Line 23), it is effected at 0.

Line 22

22	0
----	---

#### Preselection modes

- 0 \* Principal counter with 2 preselections (progressive preselections)
- 1 Principal counter with 2 preselections (P1 then as trailing preselection)
- 2 Principal counter with preselection P2, batch counter with preselection P1

Line 23

23	0
----	---

#### Reset modes

- 0 \* Principal counter and batch counter with automatic reset
- 1 Principal counter without, batch counter with automatic reset
- 2 Principal counter with, batch counter without automatic reset
- 3 Principal counter and batch counter without automatic reset

Line 24

24	0
----	---

#### Decimal point for PC, P1, P2, SC, tot

- 0 \* No decimal point
- 1 00000.0
- 2 0000.00
- 3 000.000

Line 26

26	0
----	---

#### Indication of measuring unit on display

- 0 \* without measuring unit
- 1 m
- 2 dm
- 3 cm
- 4 mm
- 5 L

Line 27

27	2
----	---

#### Assignment of lower display

The upper display always indicates the current value.

- 0 without lower display
- 1 P1 - Preselection
- 2 \* P2 - Preselection
- 3 SC - Start count
- 4 tot - Totalizer
- 5 b - Batch counter
- 6 SF - Scaling factor

Line 30

30	0
----	---

#### Counting mode Principal counter and totalizer

- 0 \* Counting input Track A, reversal Track B
- 1 Subtraction Track A adding and Track B subtracting (A-B)
- 2 Totaling Track A adding and Track B adding (A+B)
- 3 Track A 90° Track B single evaluation
- 4 Track A 90° Track B double evaluation
- 5 Track A 90° Track B quadruple evaluation



In case of the counting mode „Track A 90° Track B“, the frequency of Track A and B (Line 31 and 32) must be adjusted to 10 kHz.

Line 31

0
31

**Frequency Principal counter Track A**

- 0 \* 10 kHz
- 1 25 Hz
- 2 3 Hz

Line 32

0
32

**Frequency Principal counter Track B**

- 0 \* 10 kHz
- 1 25 Hz
- 2 3 Hz

Line 33

0
33

**Input logic and Operating thresholds of signal inputs**

- 0 \* PNP Operating threshold 6 V
- 1 NPN Operating threshold 6 V, or for Namur without explosion protection
- 2 PNP Operating threshold 3 V
- 3 NPN Operating threshold 3 V

Line 34

0
34

**Function Control input 1 (Contact 9)**

- 0 \* PC Principal counter - Reset static
- 1 PC Principal counter - Reset edge-triggered
- 2 PC Principal counter - Stop
- 3 Hold
- 4 Programming disabled
- 5 Keylock
- 6 Print (principally, 30 ms minimum pulse duration)
- 7 Principal counter- Outputs ON
- 8 Principal counter- Outputs OFF

Line 35

0
35

**Minimum pulse duration for control input 1**

- 0 \* 30 ms
- 1 100 µs

Line 36

2
36

**Function Control input 2 (Contact 10)**

- 0 PC Principal counter - Reset static
- 1 PC Principal counter - Reset edge-triggered
- 2 \* PC Principal counter - Stop
- 3 Hold
- 4 Programming disabled
- 5 Keylock
- 6 Print
- 7 Principal counter- Outputs EIN
- 8 Principal counter- Outputs AUS
- 9 External counting input for batch counter

Line 37

0
37

**Function Control input 3 (Contact 11)**

- 0 \* tot-Totalizer - Reset static
- 1 tot-Totalizer - Reset edge-triggered
- 2 b-Batch counter - Reset static
- 3 b-Batch counter - Reset edge-triggered
- 4 Programming disabled
- 5 Keylock
- 6 Print
- 7 Principal counter- Outputs EIN
- 8 Principal counter- Outputs AUS
- 9 External counting input for batch counter



Line 38

0
38

**Take-over of preselections P1, P2, SC**

- 0 \* Effective immediately
- 1 When resetting

Line 40

0
40

**Output logic**

- 0 \* Both outputs as normally open
- 1 P1 normally closed, P2 normally open
- 2 P1 normally open, P2 normally closed
- 3 Both outputs as normally closed

Line 41

0.25
41

**Output time P1**

- 0.01 s Minimum signal duration
- \* 0.25 s
- 99.99 s Maximum signal duration
- Latch = Latched signal (by pressing the C key)

Line 42

0.25
42

**Output time P2**

- 0.01 s Minimum signal duration
- \* 0.25 s
- 99.99 s Maximum signal duration
- Latch = Latched signal (by pressing the C key)

Line 50

0
50

**Code setting**

- 0 \* Code not active
- max. 9999

Line 51

0
51

**Baud rate**

- 0 \* 4800 Baud
- 1 2400 Baud
- 2 1200 Baud
- 3 600 Baud

The programming lines 51-54 are only displayed for models with interface

Line 52

0
52

**Parity**

- 0 \* Even Parity
- 1 Odd Parity
- 2 No Parity

Line 53

0
53

**Stop bits**

- 0 \* 1 Stop bit
- 1 2 Stop bits

Line 54

0
54

**Address**

- 0 \* from
- 99 to

- - - - -
-----------

The dash line indicates the end of the third programming field.  
 By pushing  $\nabla$  or  $\leftarrow$ , the instrument switches back to the beginning of the first programming field. Programming can be shut down at any time by pushing the keys  $\Delta$  and  $\leftarrow$  simultaneously.

## 5.1 Operating and preselection modes

The following paragraphs describe the operating modes.

**Progressive preselection** The NE134 counts to the next preselection after having reached a preselection. The preselections are always handled in the sequence P1, P2. You can select the preselection of your choice. An automatic reset to 0 and/or to the start count SC is possible at P2 (at the second preselection). An external or manual reset is possible at any time.

**P1 trailing preselection** The entry of preselection P1 corresponds to the interval between the previous signal and the final signal. This means that when changing the final signal, i.e. the preselection P2, the previous signal will be automatically adjusted or "trailed". This mode is well suited for switching between rapid and creeping speed in the case of length measurement applications.

## 5.2 Counting modes for principal counter and totalizer (Input Mode)

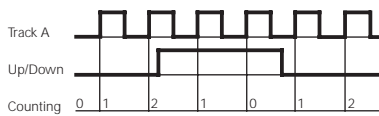

### Counting input Track A, reversal Track B (Up/Down)

The adding and/or subtracting counting directions are automatically set when selecting the operating mode in programming line 21 (diagram for adding mode).

If necessary, it is possible to use the entry Track B for reversal of direction count. Programming line 30 to digit 0.

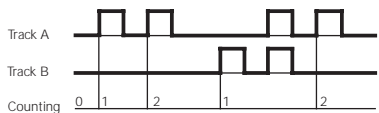

### Differential counting Track A adding and Track B subtracting (A-B)

Signal duration and particular time at choice.

Programming line 30 to digit 1.

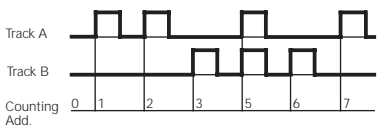

### Totaling Track A adding and Track B adding (A+B)

The adding and/or subtracting count directions are automatically set when selecting the operating mode in programming line 21.

Programming line 30 to digit 2.

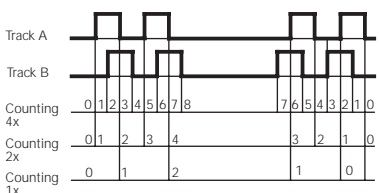

### Up and down count with two counting signals by 90° out of phase

The counting direction is automatically recognized on the basis of the 90° leading or trailing phase shift. The internal phase discriminator does the evaluation. Single, double or quadruple evaluation is possible.

Programming line 30 to digits 3, 4 or 5.

### 5.3 Output (Output Mode)

The behavior of the signal outputs is defined by the following settings under the programming field 3:

Operating mode, preselection mode, reset mode, take-over of preselections, output logic and output time P1 and P2.

The following diagrams illustrate some examples:

#### Programming

Preselection mode:  
Line 22 to 0 = Progressive preselection

Reset mode:  
Line 23 to 1 or 3  
without automatic reset

Output time P1, P2:  
Line 41, 42 to pulse or duration

Operation mode  
Line 21 to 0 = adding

Operation mode  
Line 21 to 1 = subtracting

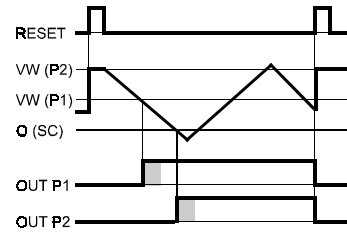
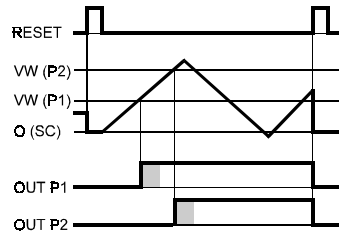

Preselection mode:  
Line 22 to 0 = Progressive preselection

Reset mode:  
Line 23 to 0 = automatic

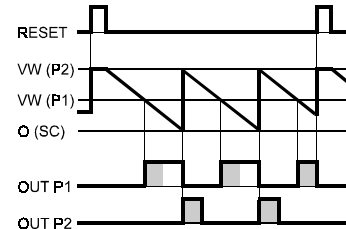
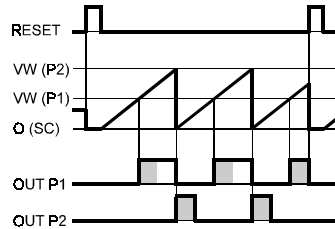

Preselection mode:  
Line 22 to 1 = Trailing preselection  
VW (P1) corresponds to the interval  
between P1 and P2. When P2 is  
changed, P1 is trailed.

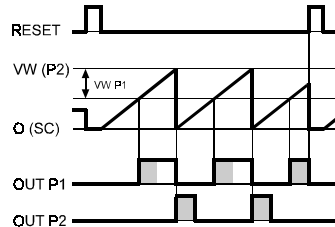

Operation mode:  
Line 21 to 2 = OUT P2 at SC,  
automatic reset at 0

Preselection mode:  
Line 22 to 0 = Progressive preselection

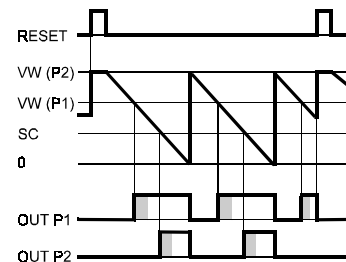

Preselection mode:  
Line 22 to 0 = Progressive preselection

Reset mode:  
Line 23 to 1 or 3  
without automatic reset

Function control input 2:  
Line 36 to 7 = OUT P1 and OUT P2  
are activated by a signal to control input 2  
(Ein St2).

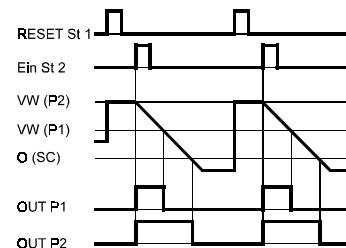
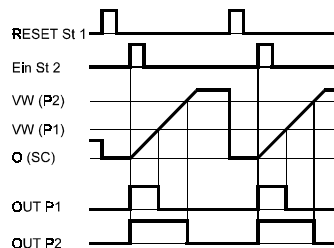

## 6 Technical data

Display	7-segment LC-display (TN) with background illumination. On two lines for actual and preselection values
Digit size	Display of actual value: 7 mm Display of preselection: 4 mm
Display of measuring unit	„mm“ „cm“ „dm“ „m“ „L“
Display of switching outputs P1, P2	Illustration as normally open or normally closed
Supply voltage	115 / 230 VAC (50 / 60 Hz) 24 / 48 VAC (50 / 60 Hz) 12...30 VDC 5 % RW
Power consumption	5 VA, 4 W
Encoder supply	10 ... 26 VDC, 60 mA
Counting rate Principal counter	3 Hz, 25 Hz or 10 kHz (for contactor 3 Hz or 25 Hz)
Counting rate Batch counter	15 Hz
Data storage	> 10 years (via EEPROM)
Fixing	Clamping frame
Front measures	48 x 48 mm, casing for front plate installation
Mounting depth	100 mm
Connections	Two plug-in screw terminals with 6 poles (grid 5.08 mm) and with 9 poles (grid 3.81 mm)
Core cross-section	Max. 1.5 mm <sup>2</sup>
Casing material	Makrolon 6485
Keypad	Short-stroke keys and front membrane
Front membrane	Polyester membrane
Weight	AC-model: ca. 260 g DC-model: ca. 140 g
Ambient temperature	0 ... +50 °C
Storage temperature	-20 ... +70 °C
Humidity	Max. relative humidity 80 %, non-condensing
Protection	Front IP 65 to DIN 40050
General rating	EN 61010 Part 1 - Protection class II - Overvoltage protection category II - Contamination factor 2
Interference immunity	EN 61000-6-2
Emitted interference	EN 50081-2

### 6.1 Dimensions and cutout measures

Measures in mm

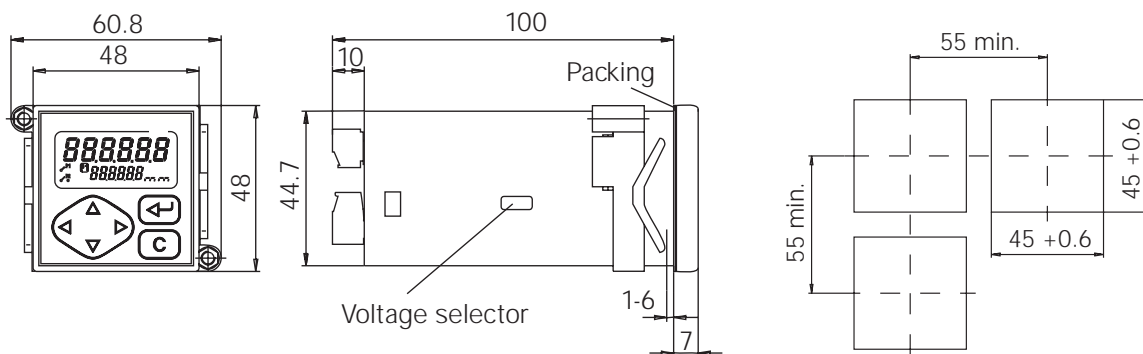

## 6.2 Error messages

*BCP 48 Error messages*

Err 1 and Err 2: Error must be fixed at the factory.

Err 6: Sequences are too quick, e.g. very short intervals between preselections at high counting rate.

- Message Err 6 can be cleared by pushing .