

# EVEREST 214 / Instruction manual



**Safety Precautions:** Installation, initial start-up and maintenance may only be performed by trained personnel. All applicable European and national regulations regarding installation of electrical equipment must be adhered to. The device may only be connected to supply power which complies with the specifications included in the technical data and on the serial plate. Do not open the housing. The device must be disconnected from all sources of power during installation and maintenance work. The device may only be operated under the conditions specified in the operating instructions.

## 1. FUNCTIONS / DESCRIPTION

- Measuring amplifier for two sensors with 0/4 to 20 mA signal, 2 or 3-wire connection
- $\mu$ -Processor controlled
- 24 V DC sensor supply power
- Integrated pulse timer, 1 second to 24 hours, e.g. for MEMPRO ventilation control
- 2 scalable measurement inputs (measured value window)
- Measurement input E1 or E2 can be individually assigned to each of the output relays, A1 through A4.
- Adjustable delay time for each limit value relay
- Adjustable hysteresis for each limit value relay
- Adjustable filter time of up to 3 seconds
- Normally closed or normally open function can be selected for each limit value relay

### Controls

Rotary switch  $\pm$ :

The desired relay (1 through 4), is selected in menu level 1.  
The desired values are selected in menu levels 2 through 6.

Pushbutton:

Used to select submenus 1 through 6.

Pushing the button in submenu 6 returns the display to menu 1.

**Note:** If none of the controls are activated for 15 seconds, the device is automatically returned to the measured value display (menu 0).

### Output relays 1 through 4

Yellow LED lights up = relay pulled in = contact closed

### Limit value

Setting range from 0 to 100% relative to the selected mA min-max  
Default setting: A1 = 80%, A2 = 60% A3 = 40% A4\* = 20%

### Delay time

Adjustable from 0.1 to 10 seconds

Limit value violation  $\rightarrow$  wait for delay time to elapse  $\rightarrow$  the relay is then switched.

Default setting: 0.1 seconds

### Hysteresis

Setting range: 0 to 99%

The output relay is not switched back until the measured value is fallen short of by the selected percentage value.

Default setting: 1%

### NC-NO selection

NO= normally open = contact is open as long as the measured value is less than the selected threshold value

NC= normally closed = contact is closed as long as the measured value is less than the selected threshold value

Default setting: NO

**Note:** All relays are open in the event of power failure or device malfunction.

### Assigning input E1 or E2 to the limit value relay

The measured value from input E1 or E2 can be assigned individually to each relay output (A1 through A4).

Default setting: E1

### OVERRANGING display

Measuring signal > mA max. value  $\rightarrow$  digital display = nnnn

Measuring signal < mA min. value  $\rightarrow$  digital display = uuu

### Pulse Timer

The pulse timer is switched on as soon as on and off-time is set to a value of greater than 0.

\*Setting values for limit value relay 4 are rendered inactive as a result.

### On-time:

The contact at relay 4 remains closed as long as the selected on-time has not yet elapsed.

Setting range: 1 second to 24 hours

### Available setting values

0\*, 1, 2, 5, 10, 30 s: No decimal point is illuminated

1, 2, 5, 10, 30 min.: The right decimal point is illuminated

1, 2, 3, 6, 12, 24 hours: The left decimal point is illuminated

Default setting: 0

### Off-time

The contact at relay 4 remains open as long as the selected off-time has not yet elapsed.

Setting values same as above

Default setting: 0

**Note:** After power failure, the device is rebooted and the program starts with on-time. If on or off-time is changed during operation, the new on or off-time becomes immediately effective.

### Scaling inputs 1 and 2

#### mA min. value

Setting range: 0 to 24 mA

Default setting: = 4 mA

#### mA max. value

Setting range: 1 to 25 mA

Default setting: = 20 mA

The percentage display can be assigned to a range of the mA measuring signal in the scaling menu.

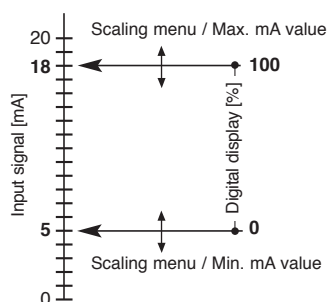

#### Example

Measuring signal 5 mA = display of 0%  
Measuring signal 18 mA = display of 100%

Settings required to this end:

Menu: Scaling E1 / mA min. = 5

Menu: Scaling E1 / mA max. = 18

# BAMO MESURES

22, Rue de la Voie des Bans - Z.I. de la Gare - 95100 ARGENTEUIL

Tél : (+33) 01 30 25 83 20 - Web : [www.bamo.fr](http://www.bamo.fr)

Fax : (+33) 01 34 10 16 05 - E-mail : [info@bamo.fr](mailto:info@bamo.fr)





## Measuring amplifier EVEREST 214

30-04-2009

232 M1 03 B

## MES

## 232-03/1

Turn Switch  LED off  LED on  LED blinking  7-Segment-Display

Push Button 

**Caption**

Note:  
the 100%-Value  
is displayed as **100**

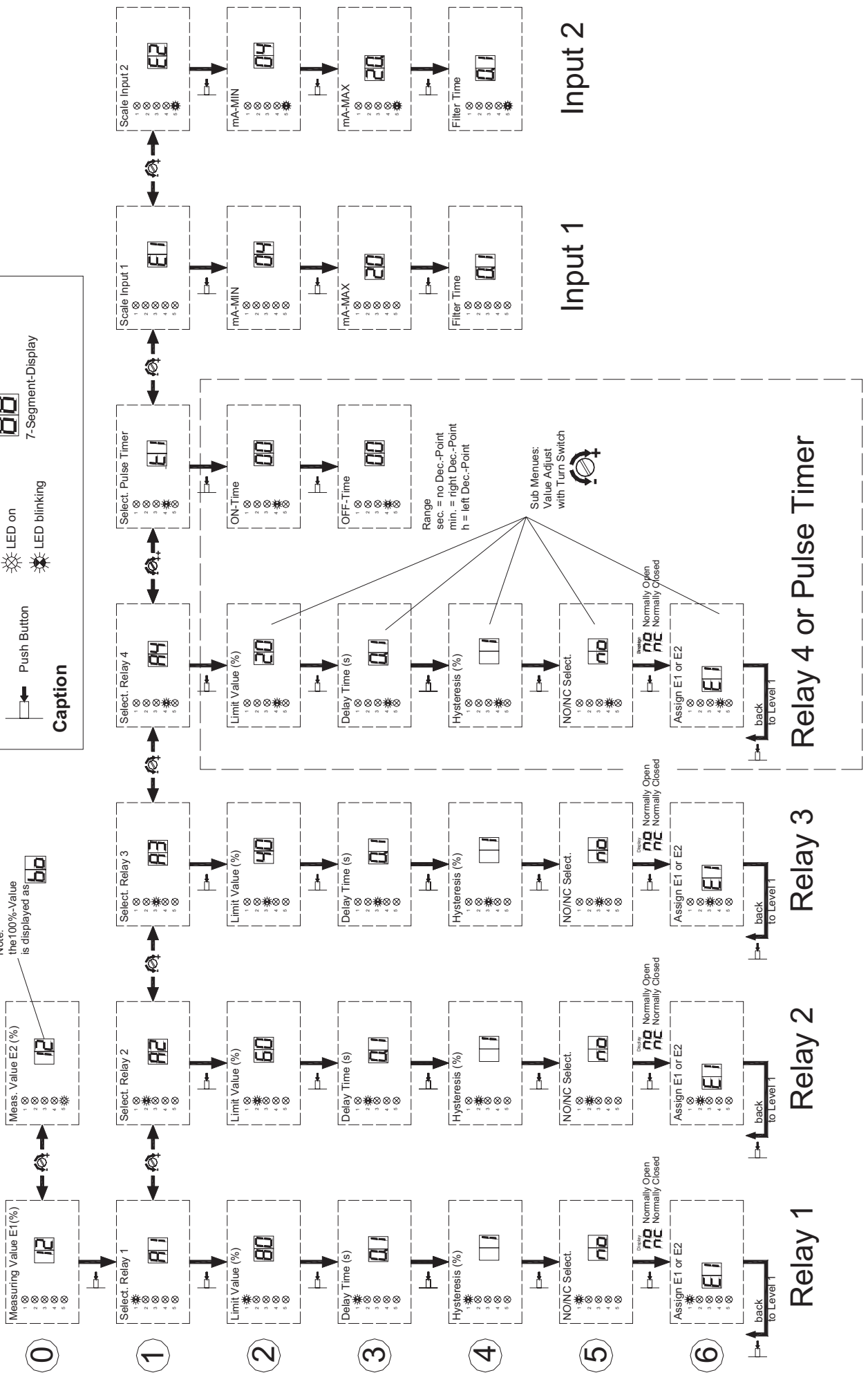

Input 2

Input 1

Relay 4 or Pulse Timer

Relay 3

Relay 2

Relay 1

## 2. ELECTRICAL CONNECTION

3/4-wire connection 0/4 - 20mA

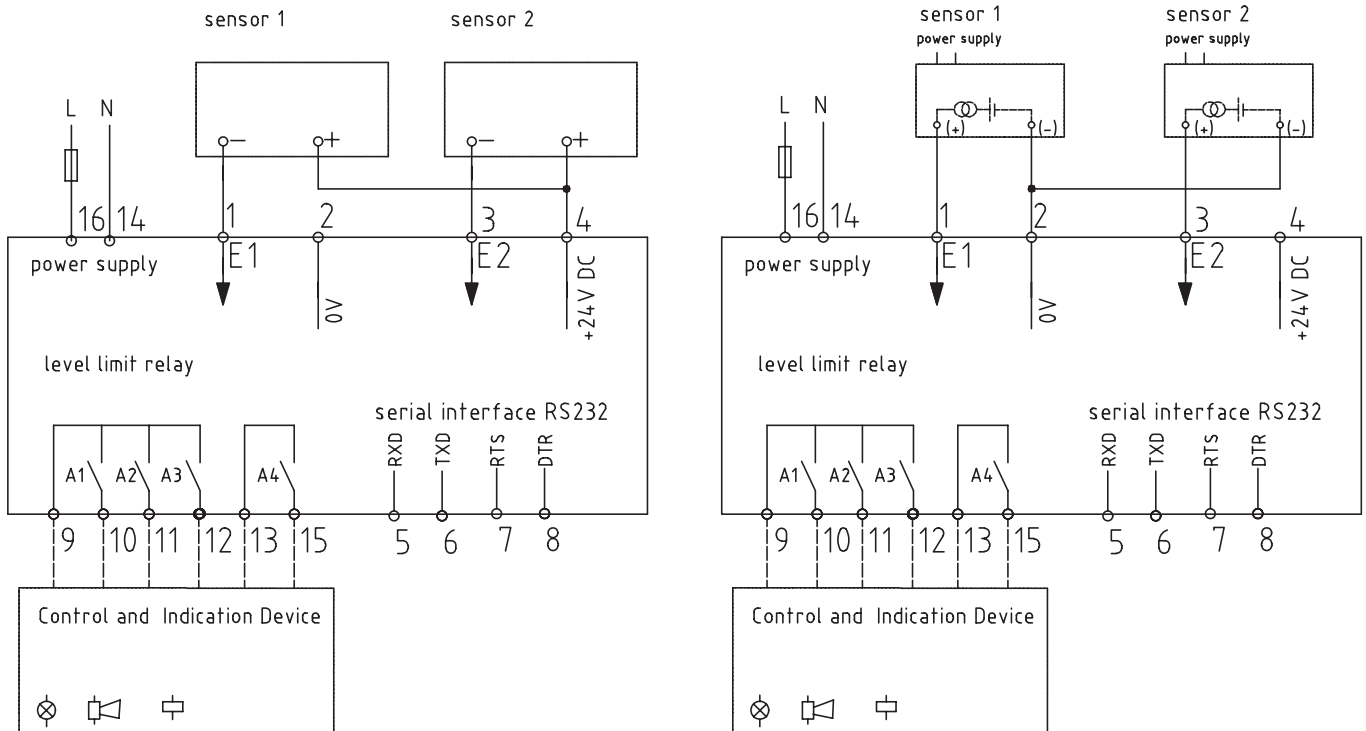

Sample schematic for sensors with 2, or 3/4 wire connection

## 3. TECHNICAL FEATURES

Main power:	230 V / 50 Hz
Power consumption:	Approximately 3 VA
Ambient temperature:	-10...+45°C
Limit relays S1, S2, S3:	Adjustable contacts, NO/NC
TIMER / Limit relay S4:	By DIP switch configuration as adjustable contact, NO/NC or pulse TIMER adjustable from 1 s to 24 h
Switching power:	250 V AC; 2.0 A / 30 V DC; 1.0 A
Sensor supply:	24 V DC, max 50 mA for 2 wires connection
Housing:	Rail DIN mounting 35 x 7.5 mm (DIN EN 50 022), IP40
Dimensions:	22.5 x 100 x 122 mm
Electrical connectors:	Terminals screw connections max. 1.5 mm <sup>2</sup>
Measuring circuit:	2 channels 0/4-20 mA
Accuracy:	0.5 % ± 0.5 digit
Filter:	Adjustable from 0.1 s to 3 s
Hysteresis:	Adjustable from 0 to 99%
Indicator:	2-digit LED display for signal in % 4 LED relay status 1 LED channel 1 or 2 indication

**CE Mark:** In accordance with low-voltage directive (2006/95/CE), EMC directives (89/336/EEC)

### Caution

*Contacts are not protected against overload – use external protective device!  
Contact protection per DIN EN 61010-1 is only assured when installed to a closed housing with at least IP 54 protection.*

## 4. MAINTENANCE

The device is maintenance-free if used for its intended purpose.