

DIAGRAMS
FOR WATER JET PUMP

SP 957



PUMPING

MIXING

VACUUM PRODUCTION

BAMO MESURES

22, Rue de la Voie des Bans - Z.I. de la Gare - 95100 ARGENTEUIL

Tél : (+33) 01 30 25 83 20 - Web : www.bamo.fr

Fax : (+33) 01 34 10 16 05 - E-mail : info@bamo.fr

Diagrams
for water jet pump

SP 957

02-01-2013

957 M1 02 A

MES

957-02/1

Choice of jet pump is done from diagrams including different process parameters (pressures/bore/flow rate vs. water/water or air /water).
Vacuumed flow rate fluctuates a lot with variations of back-pressure.

Diagrams are established with vacuum height of 1 m for water. Curves are for a difference of 0.1 bar between driving fluid pressure and back-pressure.

These diagrams are empiric data and we are not responsible of difference in results with application on a process line.

Nozzle is delivered undrilled. Fine adjustment may be done step by step, increasing the bore diameter.

- Mounting could be done in any position.

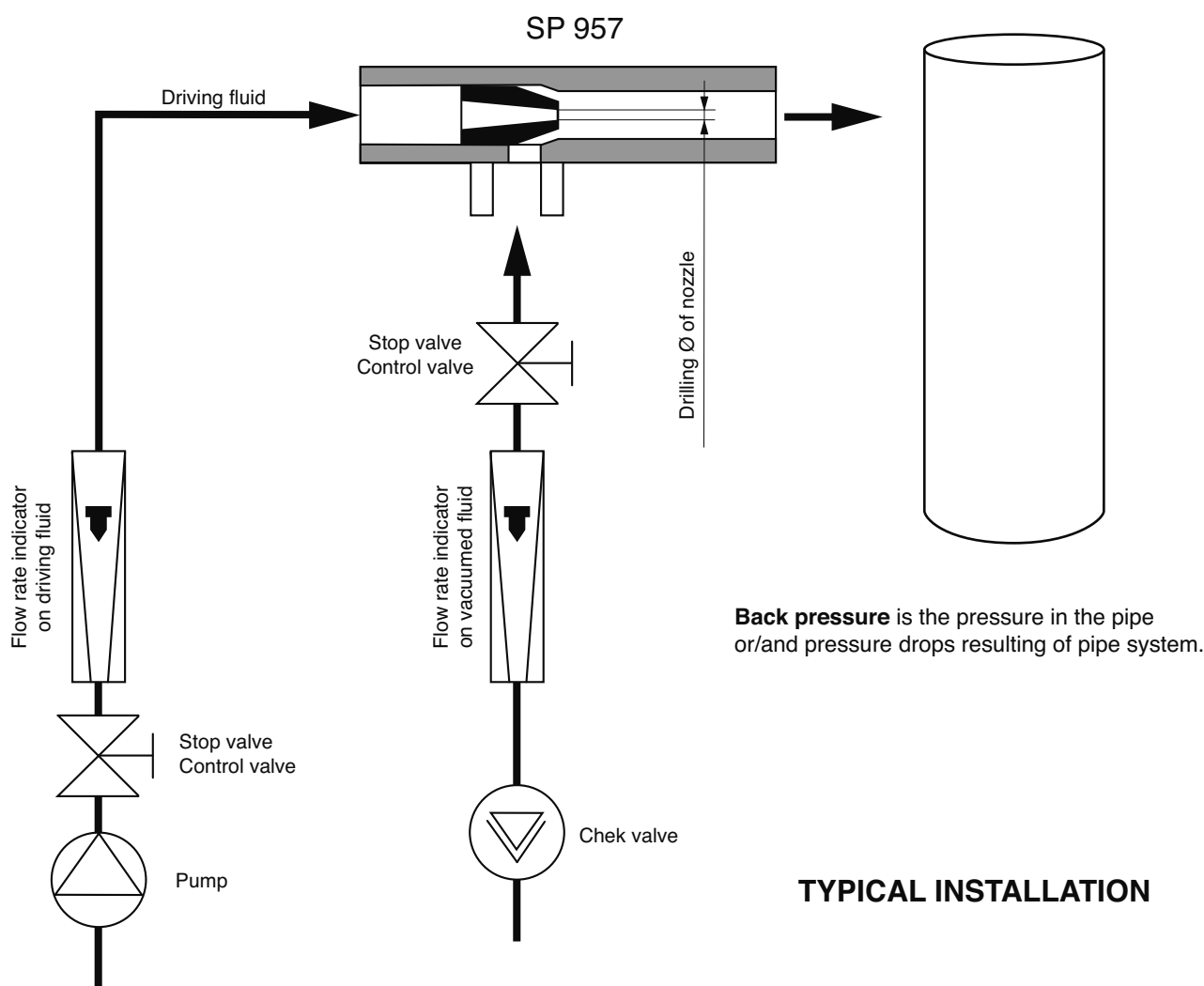

DRIVING FLUID: WATER

VACUUMED FLUID: WATER

WITH NOZZLE DRILLED BORE Ø 1.5 mm

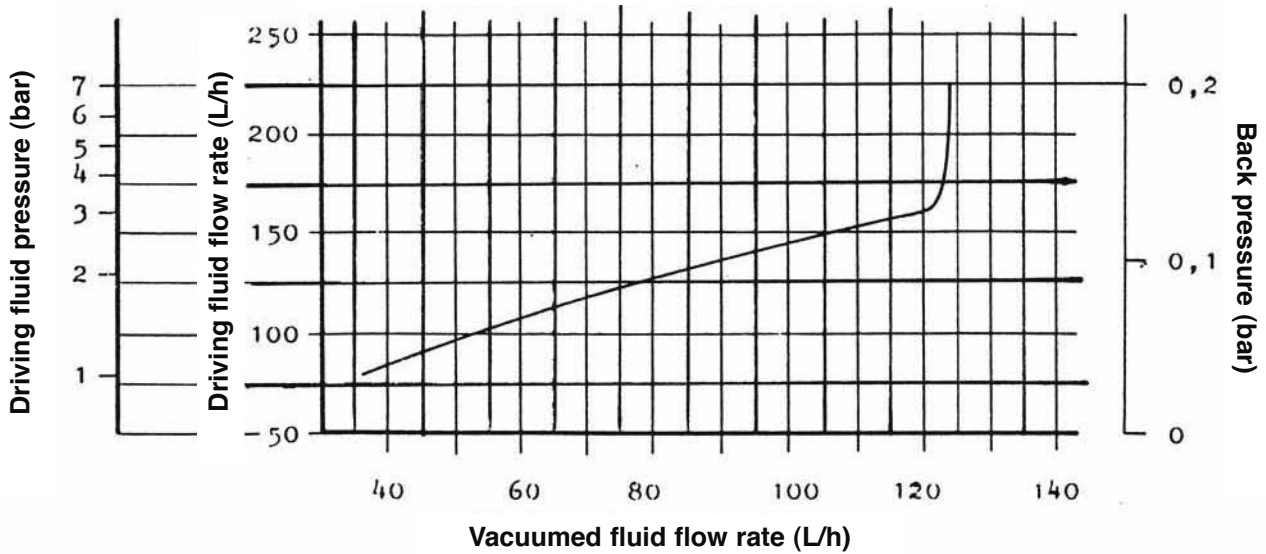

WITH NOZZLE DRILLED BORE Ø 2 mm

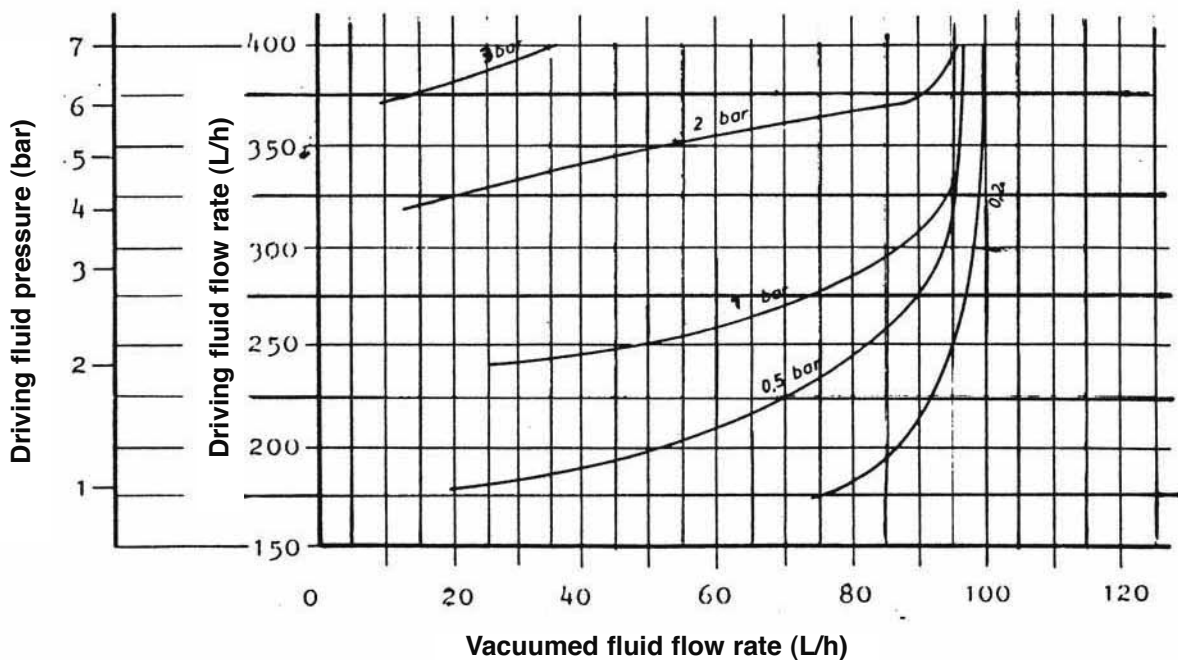

22, Rue de la Voie des Bans - Z.I. de la Gare - 95100 ARGENTEUIL
Tél : (+33) 01 30 25 83 20 - Web : www.bamo.fr
Fax : (+33) 01 34 10 16 05 - E-mail : info@bamo.fr

Diagrams
for water jet pump
SP 957.10

02-01-2013

957 M1 02 A

MES

957-02/3

DRIVING FLUID: WATER

VACUUMED FLUID: AIR

WITH NOZZLE DRILLED BORE Ø 1.5 mm

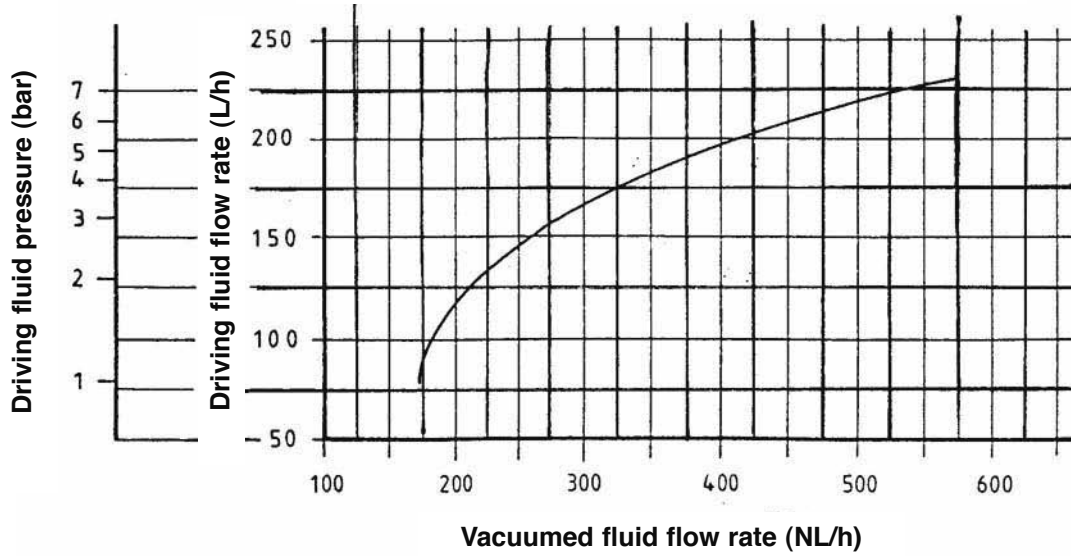

WITH NOZZLE DRILLED BORE Ø 2 mm

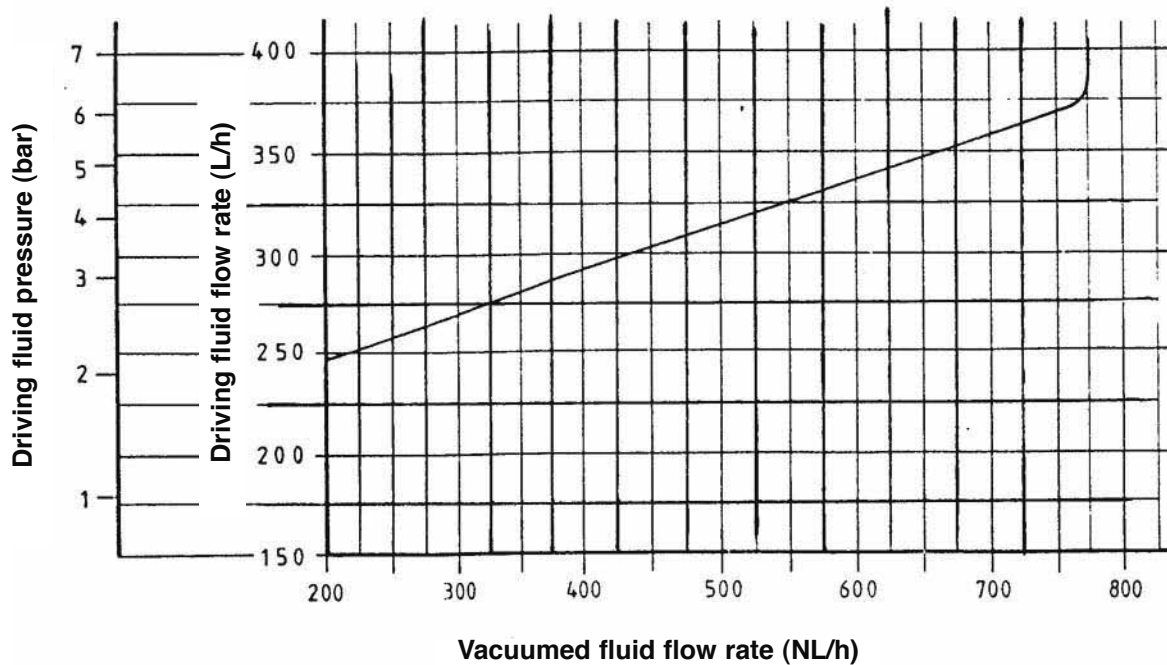

DRIVING FLUID: WATER

VACUUMED FLUID: WATER

WITH NOZZLE DRILLED BORE Ø 2 mm

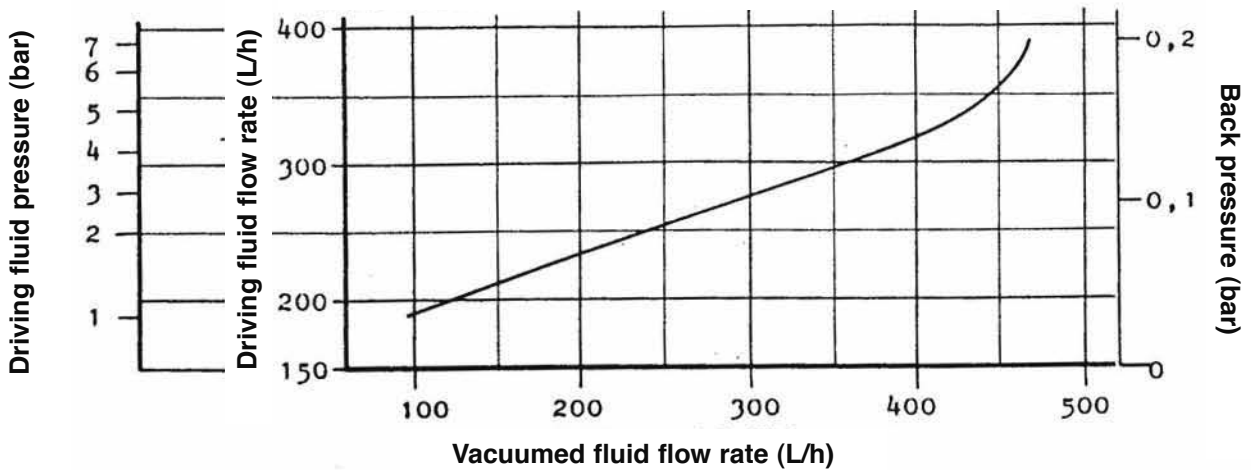

WITH NOZZLE DRILLED BORE Ø 3 mm

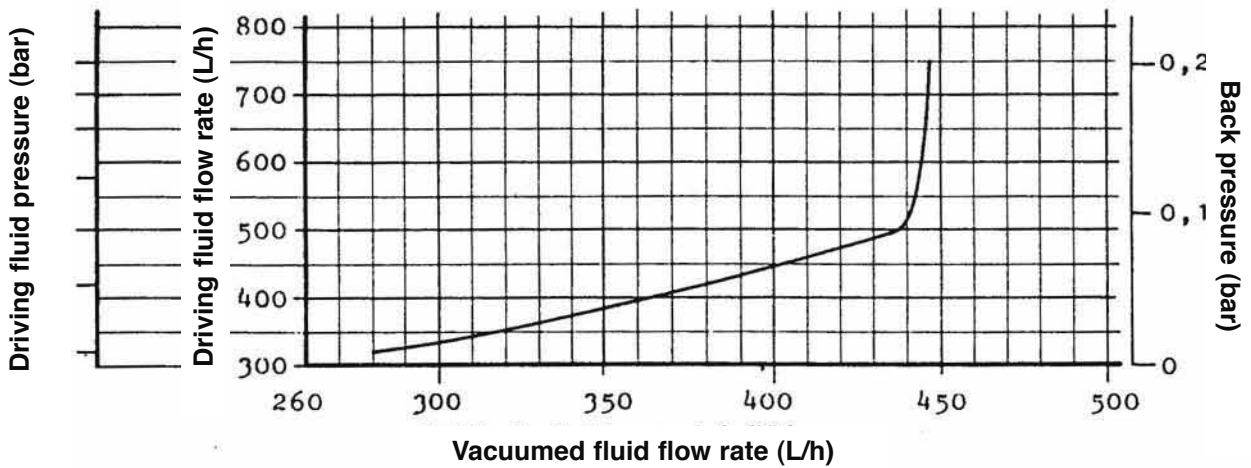

WITH NOZZLE DRILLED BORE Ø 4 mm

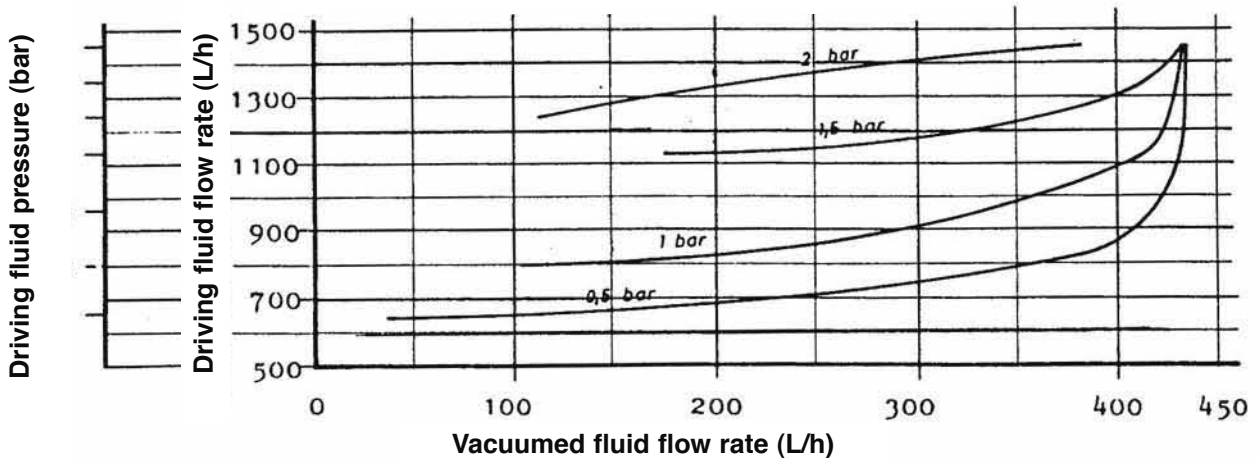

BAMO MESURES

22, Rue de la Voie des Bans - Z.I. de la Gare - 95100 ARGENTEUIL

Tél : (+33) 01 30 25 83 20 - Web : www.bamo.fr

Fax : (+33) 01 34 10 16 05 - E-mail : info@bamo.fr

Diagrams
for water jet pump
SP 957.15

02-01-2013

957 M1 02 A

MES

957-02/5

DRIVING FLUID: WATER

VACUUMED FLUID: AIR

WITH NOZZLE DRILLED BORE Ø 2 mm

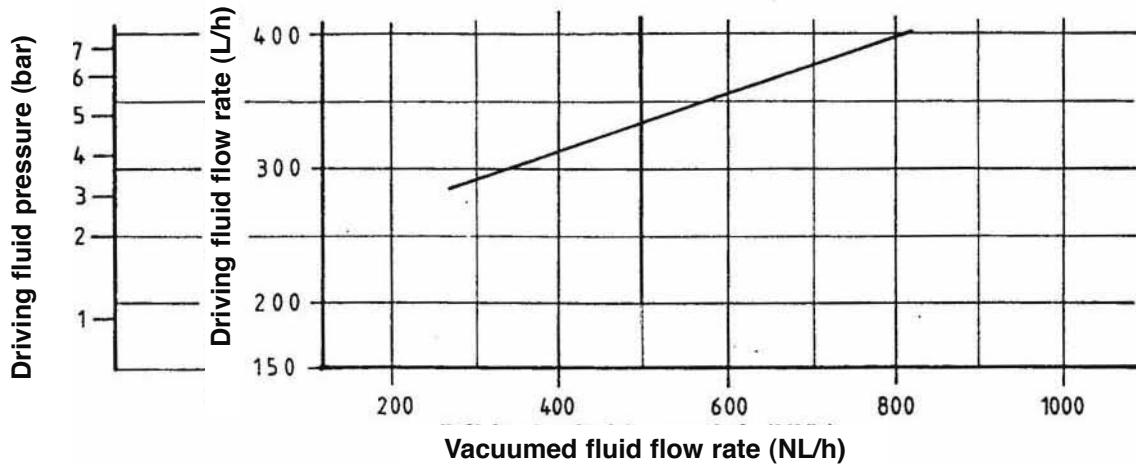

WITH NOZZLE DRILLED BORE Ø 3 mm

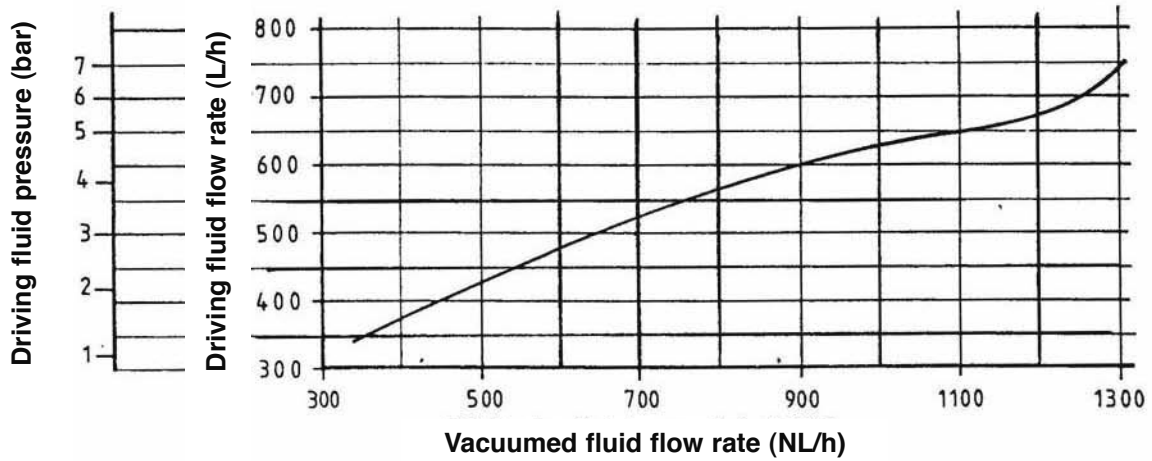

WITH NOZZLE DRILLED BORE Ø 4 mm

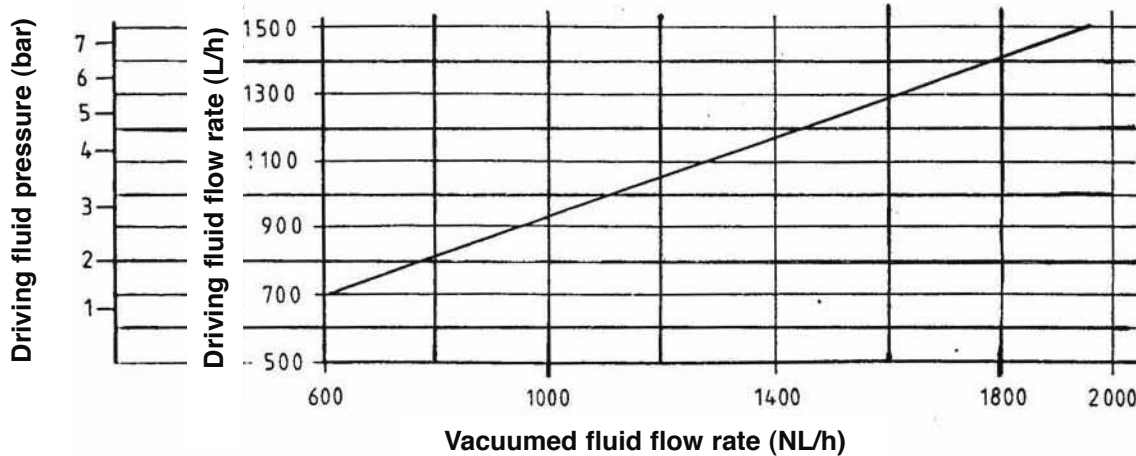

22, Rue de la Voie des Bans - Z.I. de la Gare - 95100 ARGENTEUIL
Tél : (+33) 01 30 25 83 20 - Web : www.bamo.fr
Fax : (+33) 01 34 10 16 05 - E-mail : info@bamo.fr

Diagrams
for water jet pump
SP 957.15

02-01-2013

957 M1 02 A

MES

957-02/6

DRIVING FLUID: WATER

VACUUMED FLUID: WATER

WITH NOZZLE DRILLED BORE Ø 3 mm

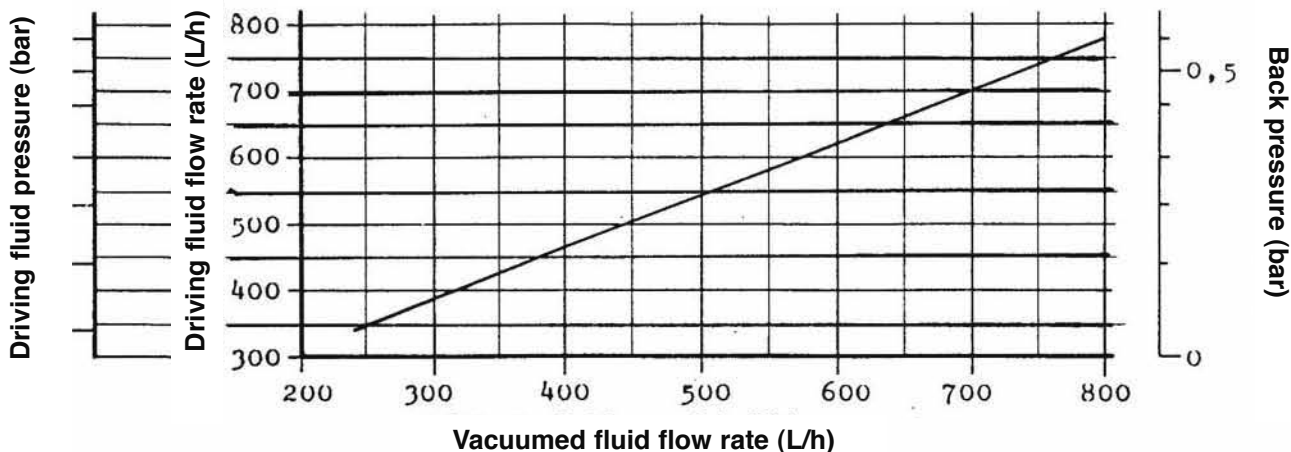

WITH NOZZLE DRILLED BORE Ø 4.5 mm

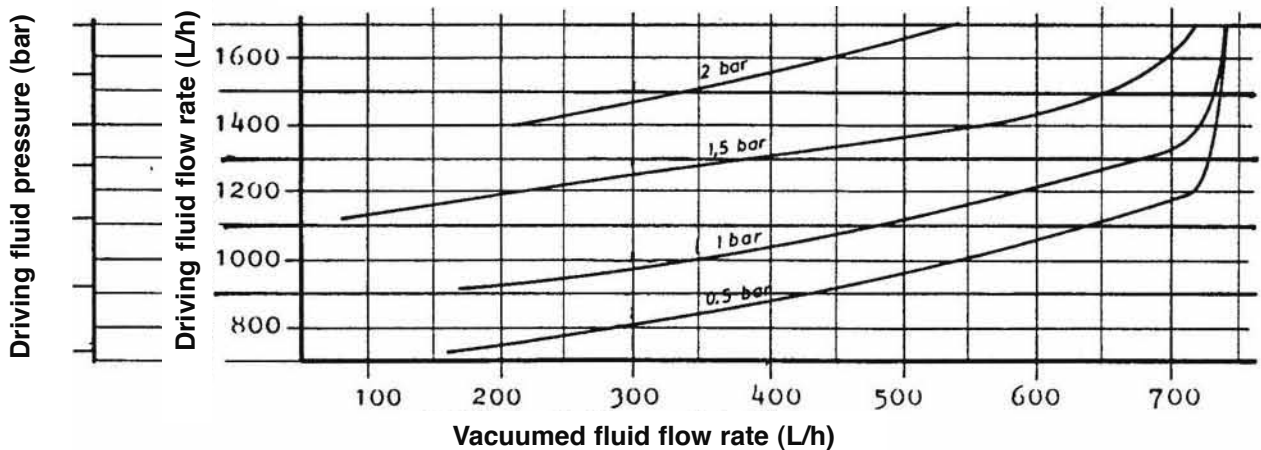

WITH NOZZLE DRILLED BORE Ø 6 mm

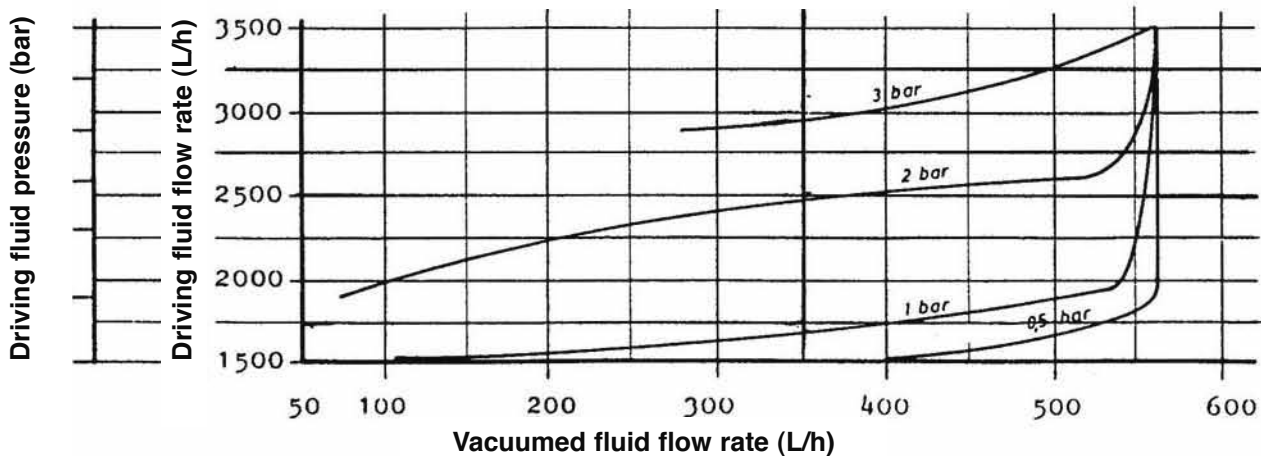

22, Rue de la Voie des Bans - Z.I. de la Gare - 95100 ARGENTEUIL
 Tél : (+33) 01 30 25 83 20 - Web : www.bamo.fr
 Fax : (+33) 01 34 10 16 05 - E-mail : info@bamo.fr

**Diagrams
 for water jet pump
 SP 957.20**

02-01-2013

957 M1 02 A

MES

957-02/7

DRIVING FLUID: WATER

VACUUMED FLUID: AIR

WITH NOZZLE DRILLED BORE Ø 3 mm

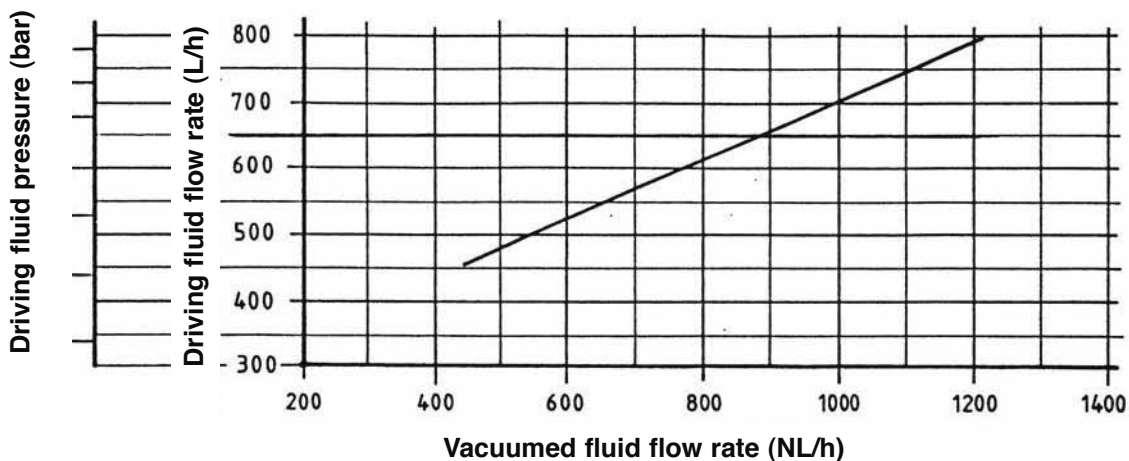

WITH NOZZLE DRILLED BORE Ø 4.5 mm

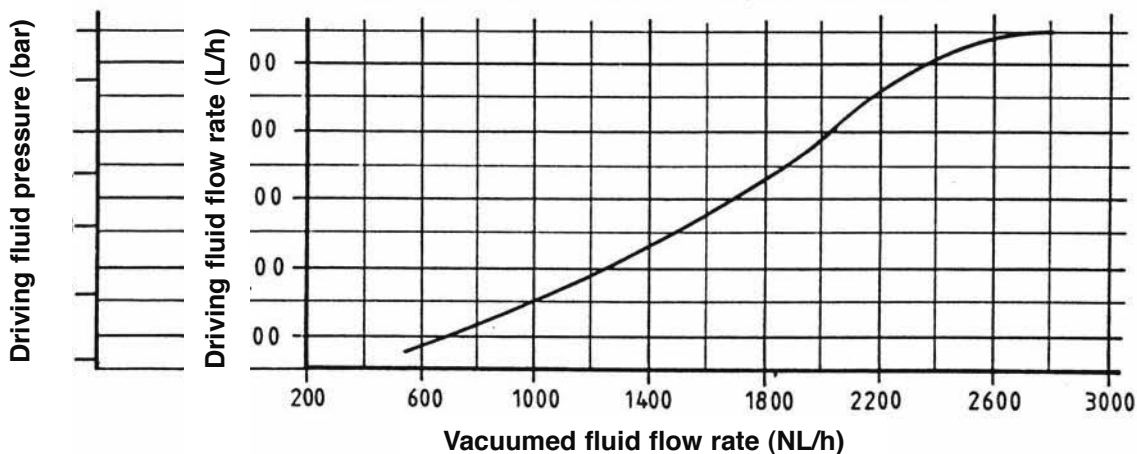

WITH NOZZLE DRILLED BORE Ø 6 mm

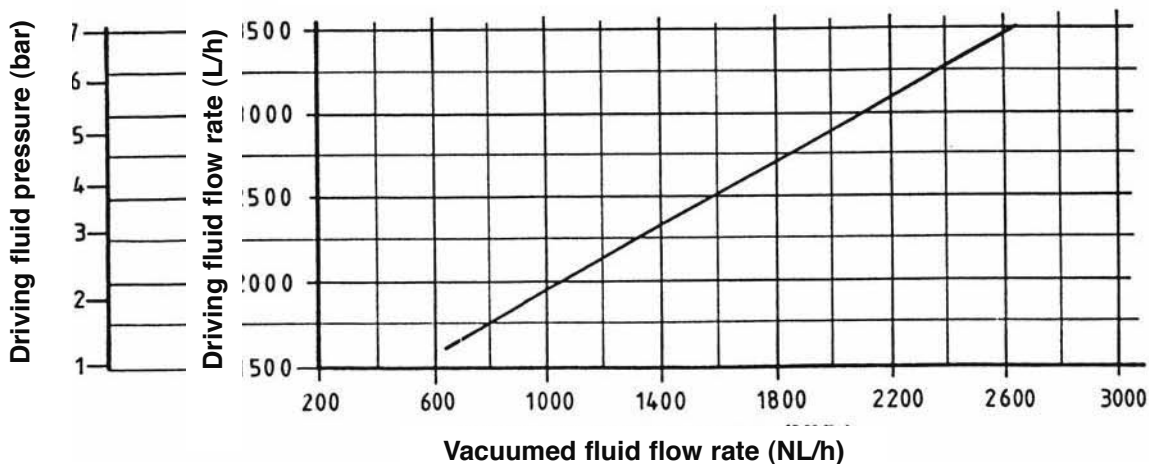

22, Rue de la Voie des Bans - Z.I. de la Gare - 95100 ARGENTEUIL
Tél : (+33) 01 30 25 83 20 - Web : www.bamo.fr
Fax : (+33) 01 34 10 16 05 - E-mail : info@bamo.fr

Diagrams
for water jet pump
SP 957.20

02-01-2013

957 M1 02 A

MES

957-02/8

WITH NOZZLE DRILLED BORE Ø 2.5 mm

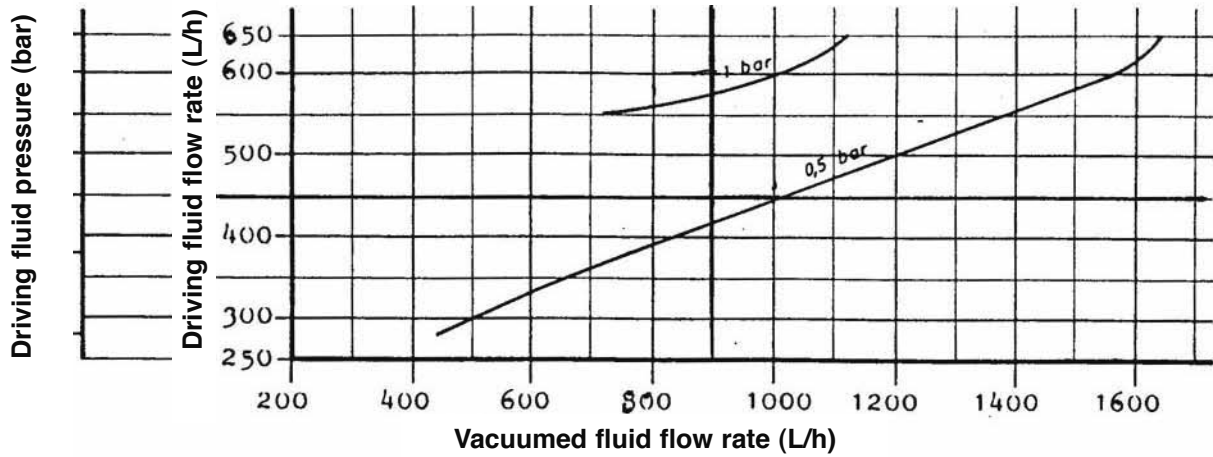

WITH NOZZLE DRILLED BORE Ø 4 mm

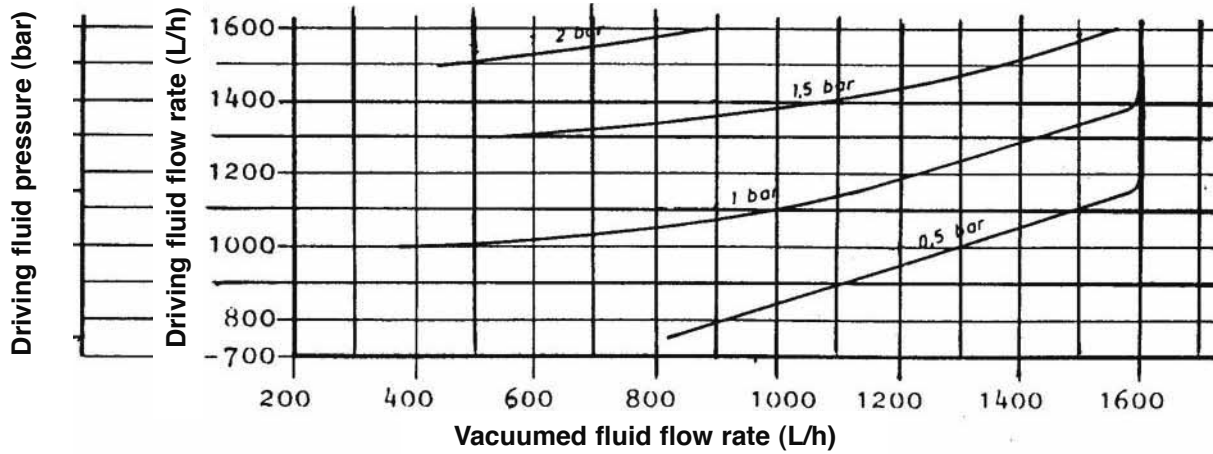

WITH NOZZLE DRILLED BORE Ø 5 mm

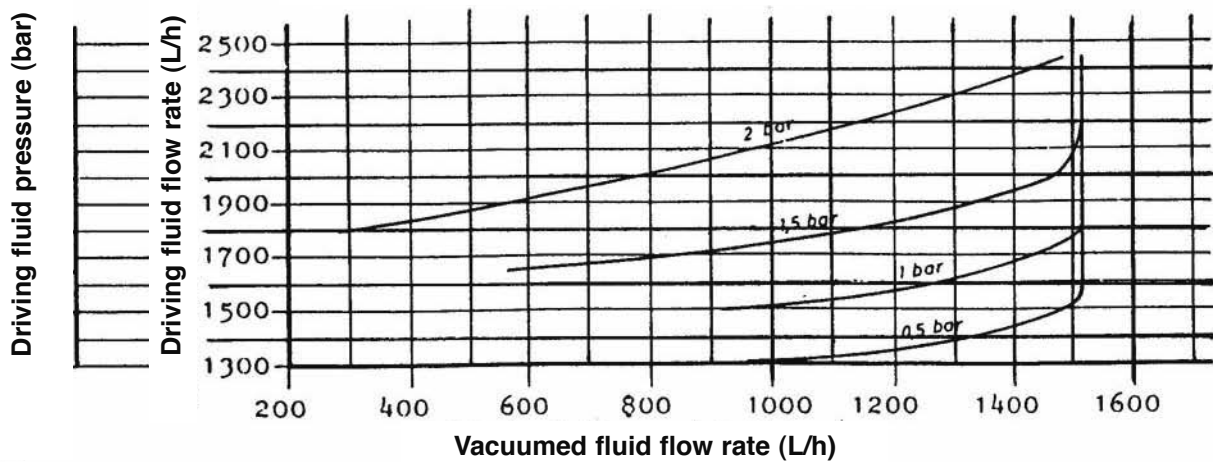

DRIVING FLUID: WATER

VACUUMED FLUID: AIR

WITH NOZZLE DRILLED BORE Ø 2.5 mm

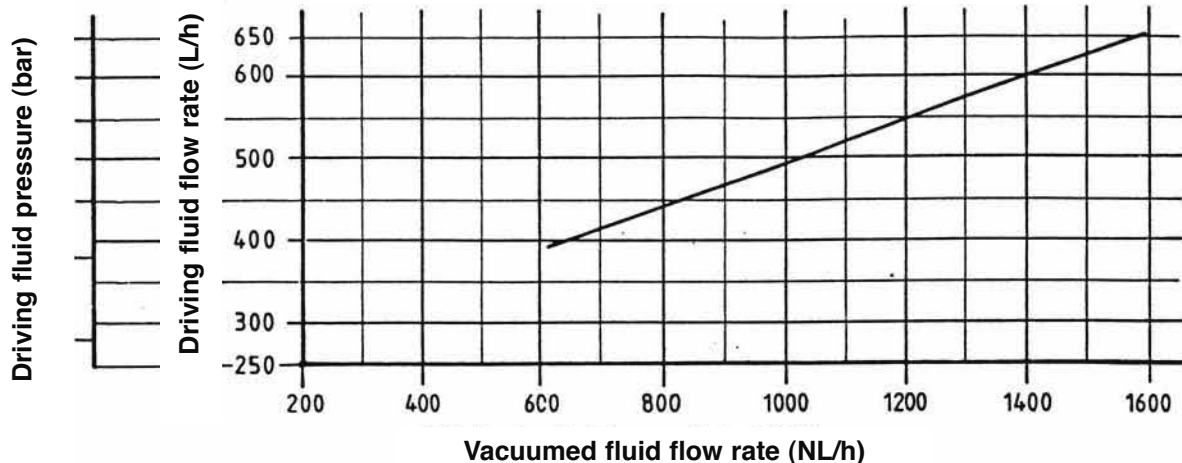

WITH NOZZLE DRILLED BORE Ø 4 mm

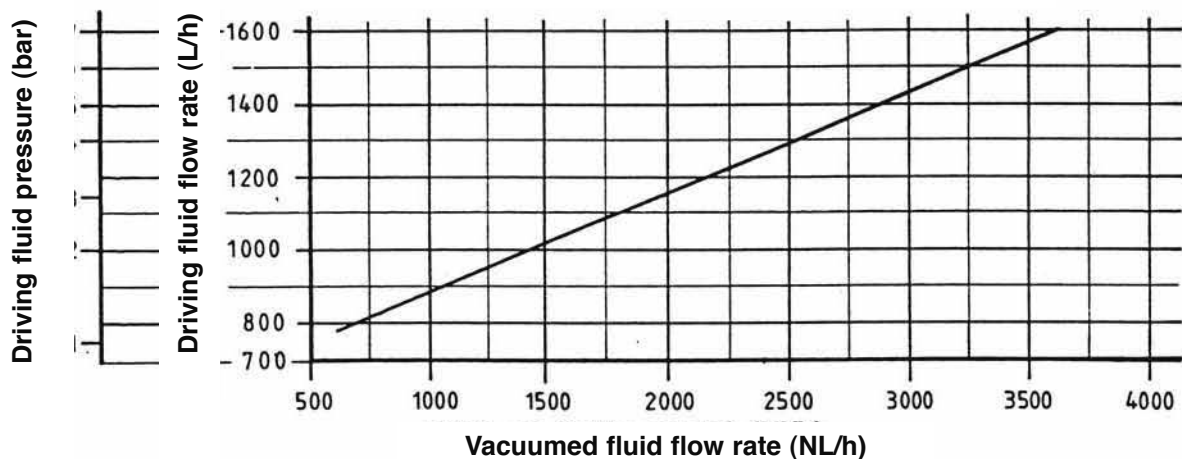

WITH NOZZLE DRILLED BORE Ø 5 mm

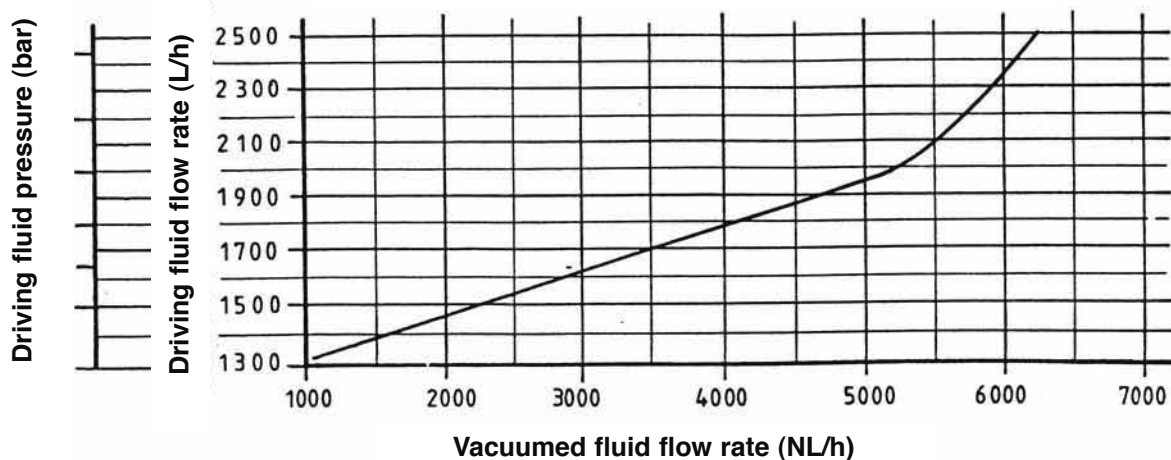

22, Rue de la Voie des Bans - Z.I. de la Gare - 95100 ARGENTEUIL
Tél : (+33) 01 30 25 83 20 - Web : www.bamo.fr
Fax : (+33) 01 34 10 16 05 - E-mail : info@bamo.fr

Diagrams
for water jet pump
SP 957.25

02-01-2013

957 M1 02 A

MES

957-02/10

DRIVING FLUID: WATER

VACUUMED FLUID: WATER

WITH NOZZLE DRILLED BORE Ø 3 mm

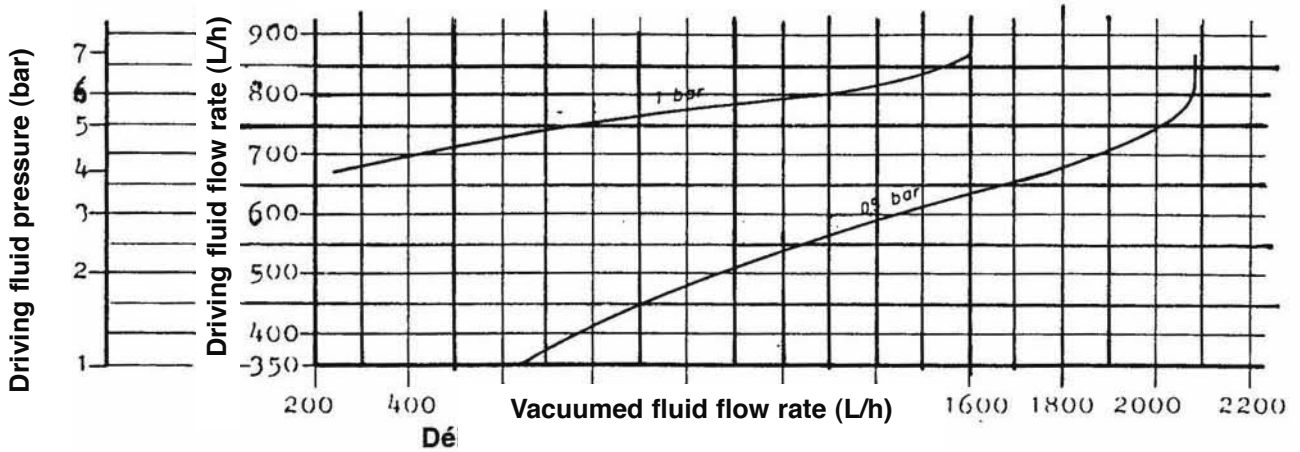

WITH NOZZLE DRILLED BORE Ø 4.5 mm

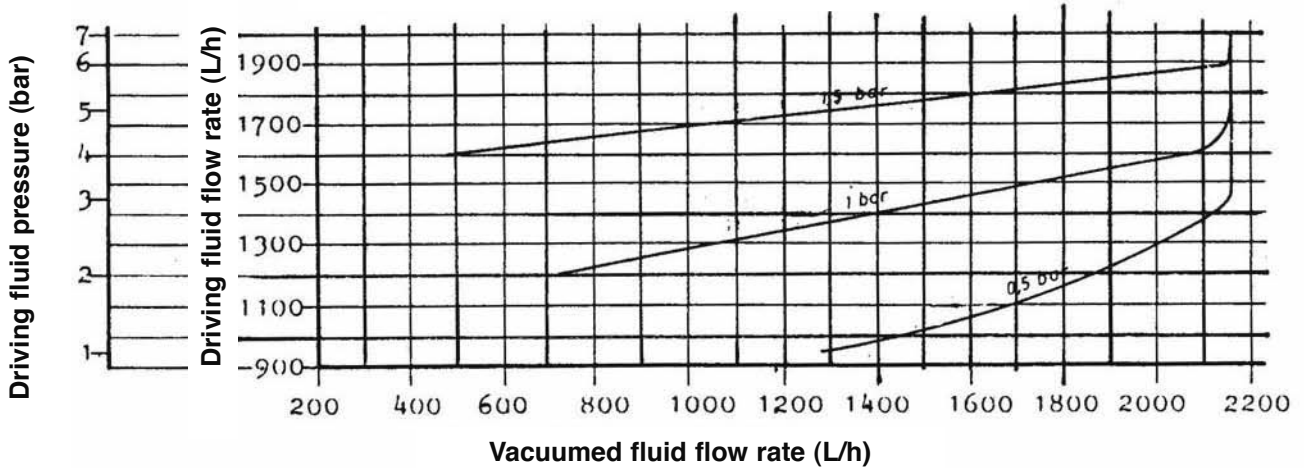

WITH NOZZLE DRILLED BORE Ø 6 mm

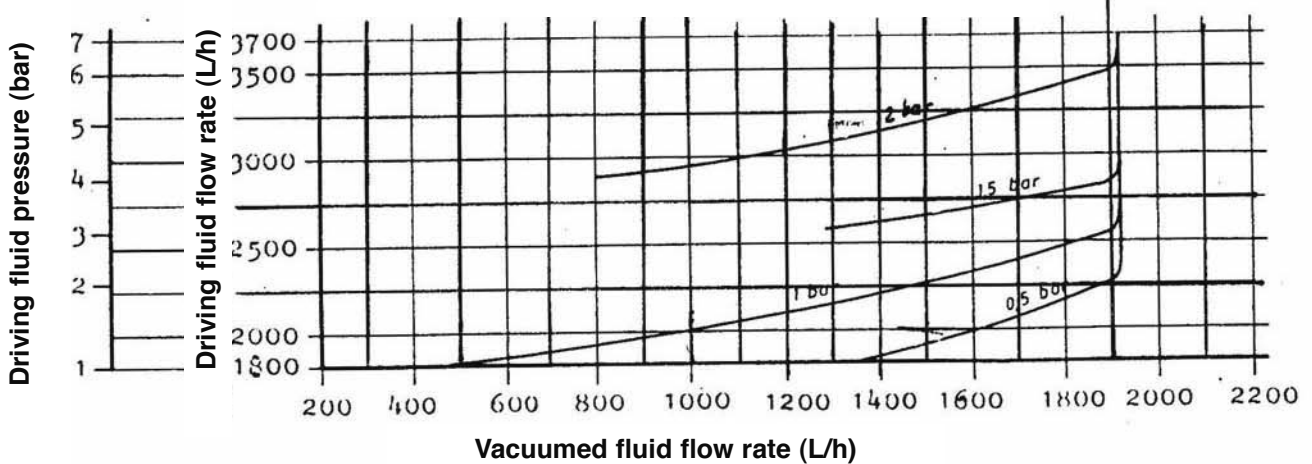

BAMO MESURES

22, Rue de la Voie des Bans - Z.I. de la Gare - 95100 ARGENTEUIL

Tél : (+33) 01 30 25 83 20 - Web : www.bamo.fr

Fax : (+33) 01 34 10 16 05 - E-mail : info@bamo.fr

Diagrams
for water jet pump
SP 957.32

02-01-2013

957 M1 02 A

MES

957-02/11

DRIVING FLUID: WATER

VACUUMED FLUID: AIR

WITH NOZZLE DRILLED BORE Ø 3 mm

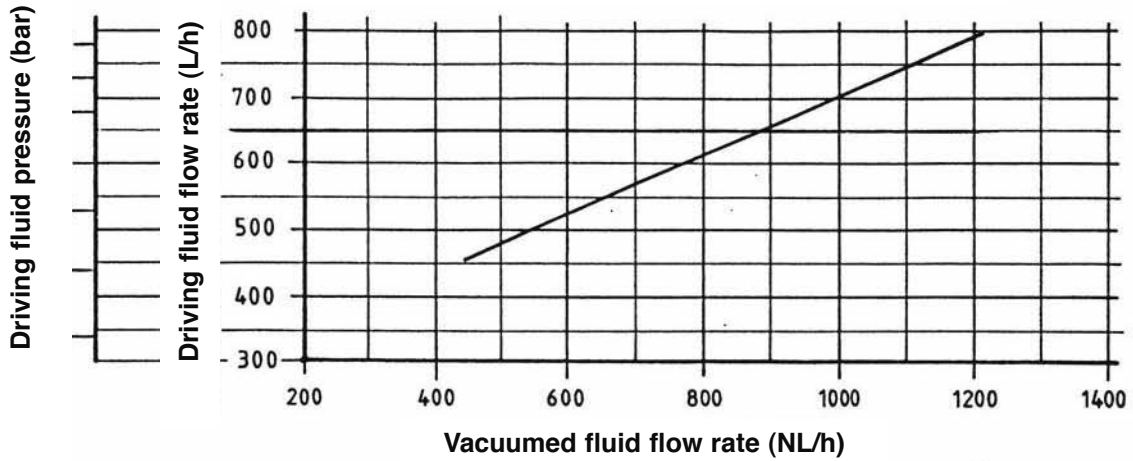

WITH NOZZLE DRILLED BORE Ø 4.5 mm

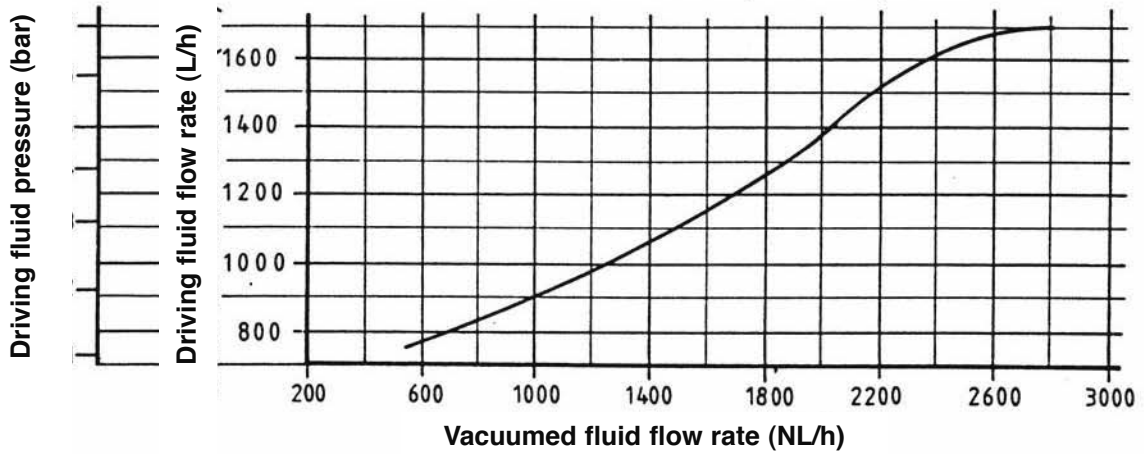

WITH NOZZLE DRILLED BORE Ø 6 mm

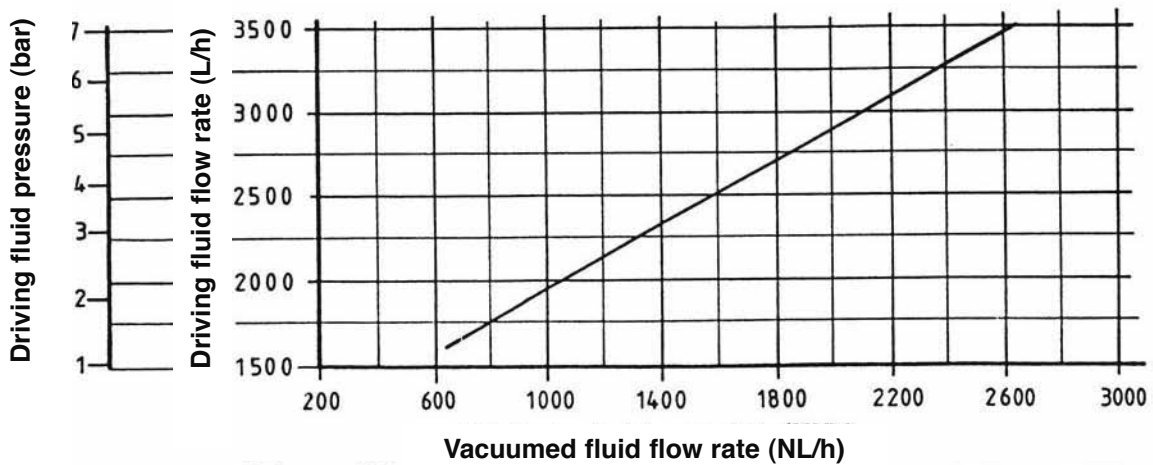

22, Rue de la Voie des Bans - Z.I. de la Gare - 95100 ARGENTEUIL
Tél : (+33) 01 30 25 83 20 - Web : www.bamo.fr
Fax : (+33) 01 34 10 16 05 - E-mail : info@bamo.fr

**Diagrams
for water jet pump
SP 957.32**

02-01-2013

957 M1 02 A

MES

957-02/12

DRIVING FLUID: WATER

VACUUMED FLUID: WATER

WITH NOZZLE DRILLED BORE Ø 3.5 mm

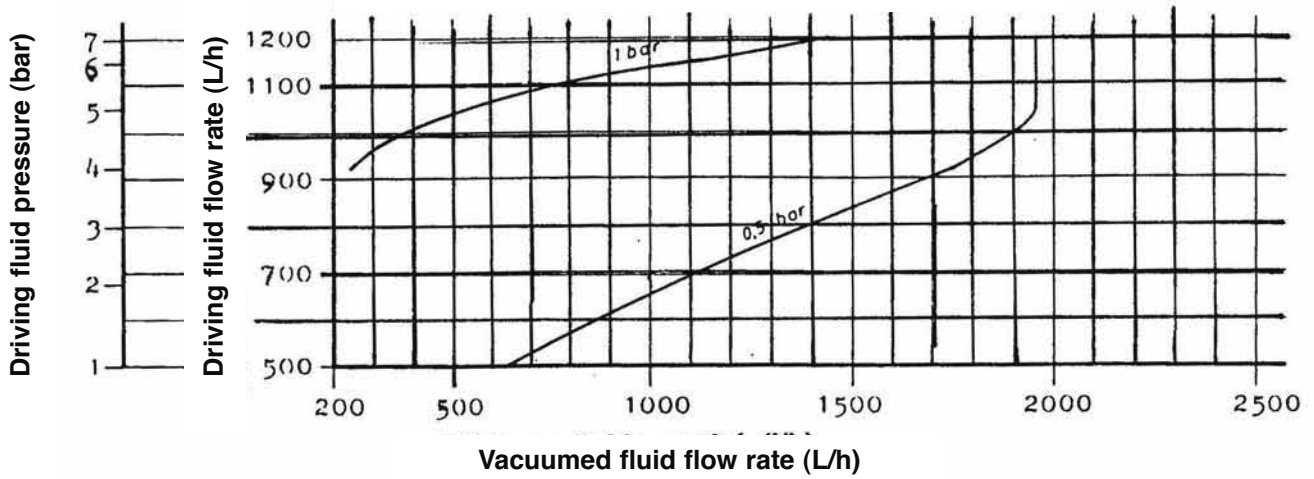

WITH NOZZLE DRILLED BORE Ø 5.5 mm

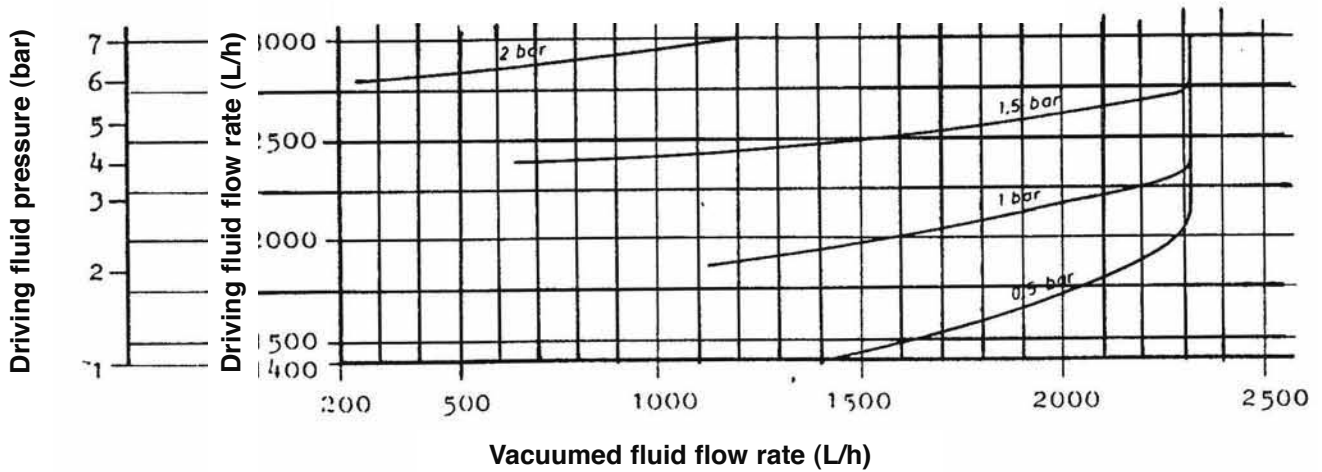

WITH NOZZLE DRILLED BORE Ø 7.5 mm

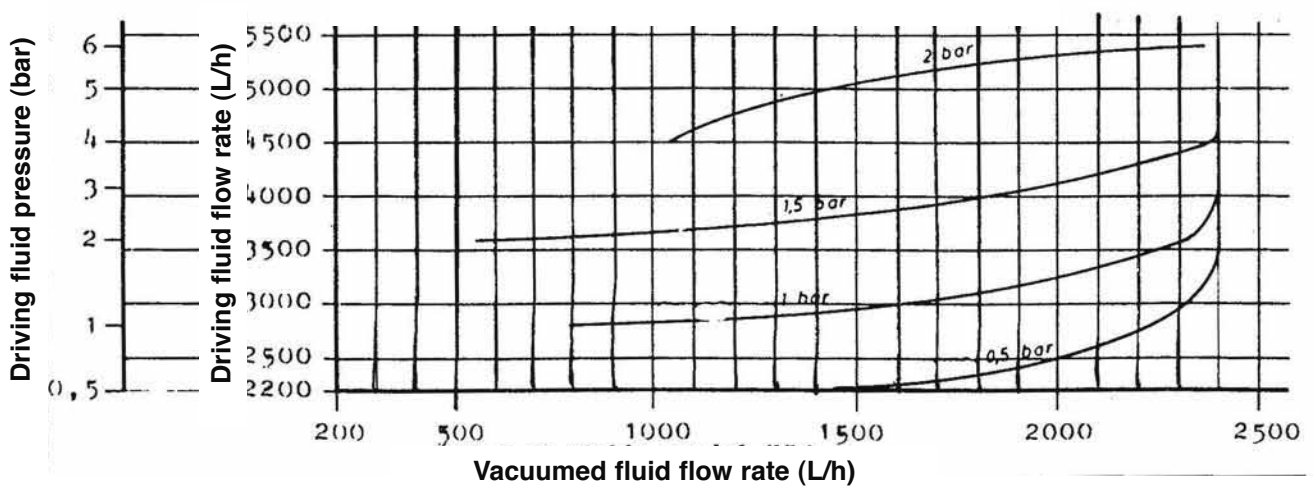

22, Rue de la Voie des Bans - Z.I. de la Gare - 95100 ARGENTEUIL
Tél : (+33) 01 30 25 83 20 - Web : www.bamo.fr
Fax : (+33) 01 34 10 16 05 - E-mail : info@bamo.fr

Diagrams
for water jet pump
SP 957.40

02-01-2013

957 M1 02 A

MES

957-02/13

DRIVING FLUID: WATER

VACUUMED FLUID: AIR

WITH NOZZLE DRILLED BORE Ø 3.5 mm

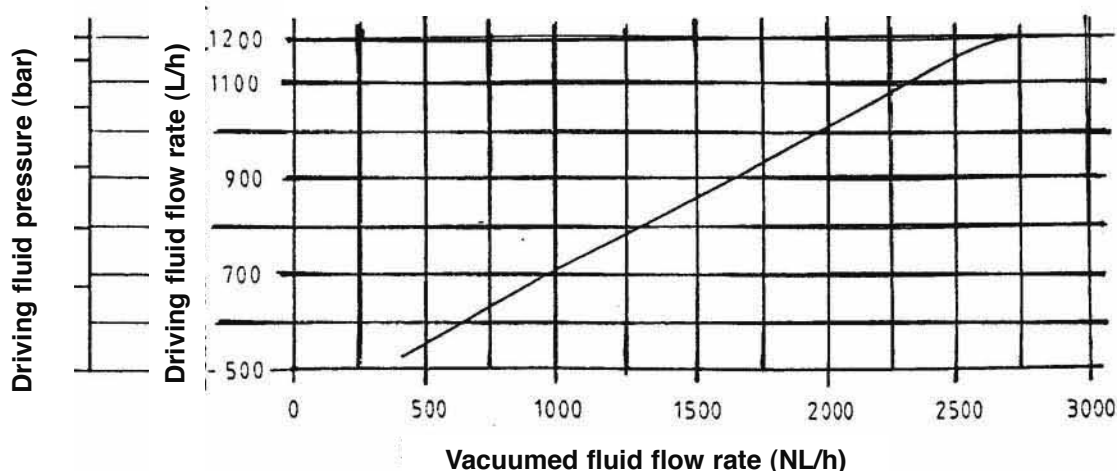

WITH NOZZLE DRILLED BORE Ø 5.5 mm

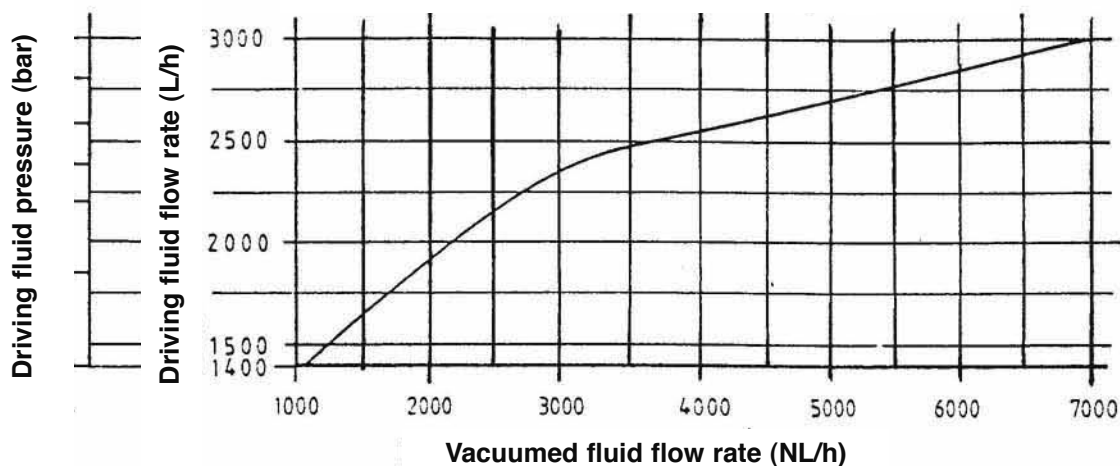

WITH NOZZLE DRILLED BORE Ø 7.5 mm

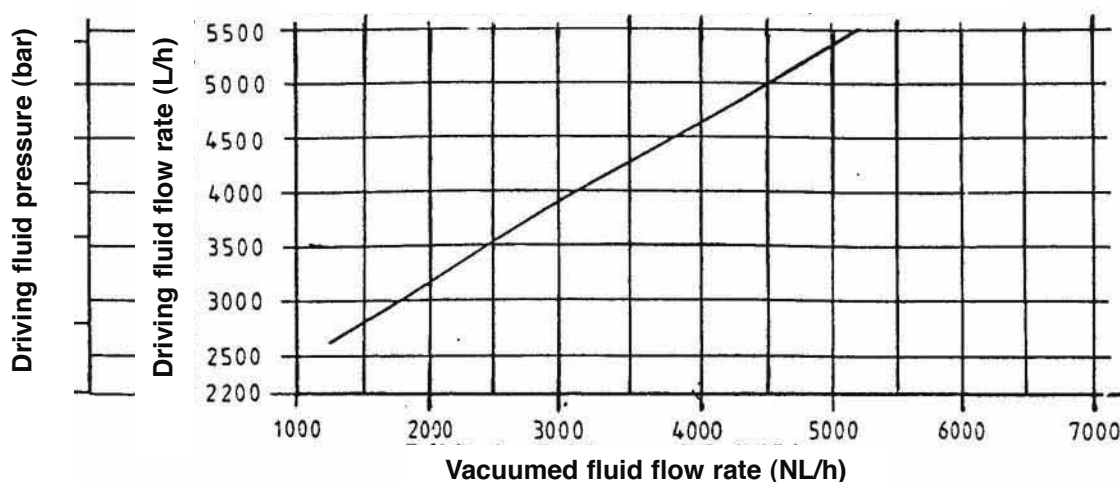

22, Rue de la Voie des Bans - Z.I. de la Gare - 95100 ARGENTEUIL
Tél : (+33) 01 30 25 83 20 - Web : www.bamo.fr
Fax : (+33) 01 34 10 16 05 - E-mail : info@bamo.fr

**Diagrams
for water jet pump
SP 957.40**

02-01-2013

957 M1 02 A

MES

957-02/14

DRIVING FLUID: WATER

VACUUMED FLUID: WATER

WITH NOZZLE DRILLED BORE Ø 5 mm

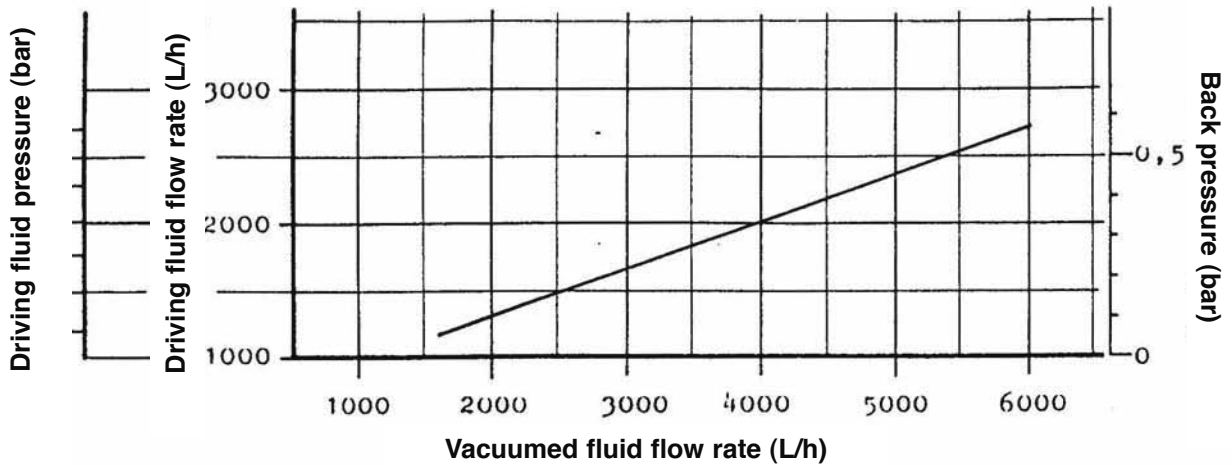

WITH NOZZLE DRILLED BORE Ø 7 mm

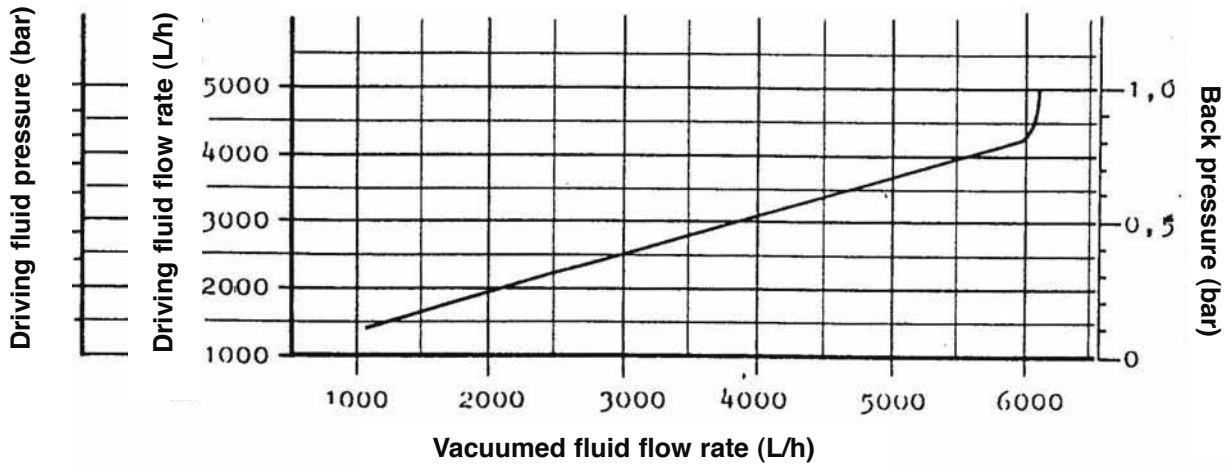

WITH NOZZLE DRILLED BORE Ø 9 mm

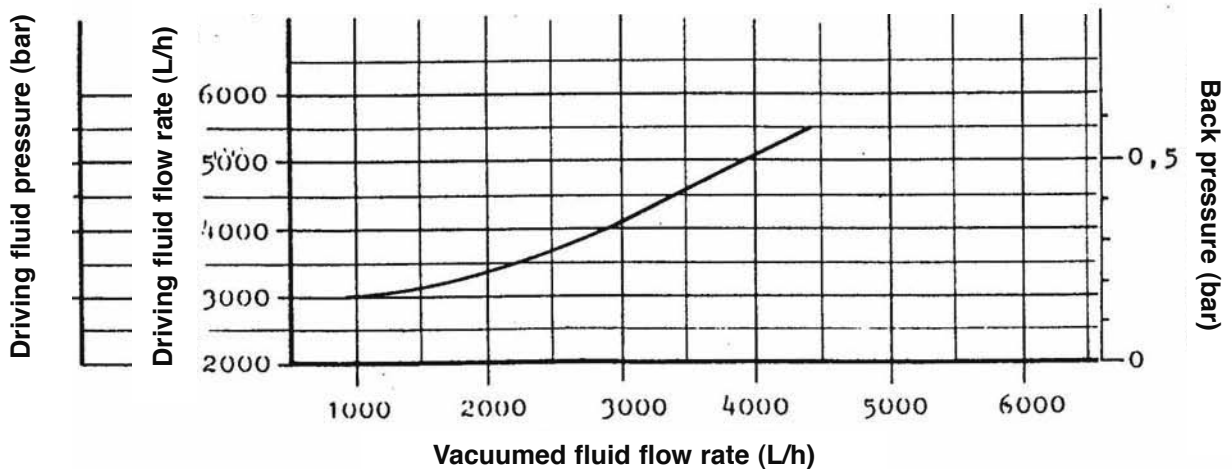

22, Rue de la Voie des Bans - Z.I. de la Gare - 95100 ARGENTEUIL
Tél : (+33) 01 30 25 83 20 - Web : www.bamo.fr
Fax : (+33) 01 34 10 16 05 - E-mail : info@bamo.fr

Diagrams
for water jet pump
SP 957.50

02-01-2013

957 M1 02 A

MES

957-02/15

DRIVING FLUID: WATER

VACUUMED FLUID: AIR

WITH NOZZLE DRILLED BORE Ø 5 mm

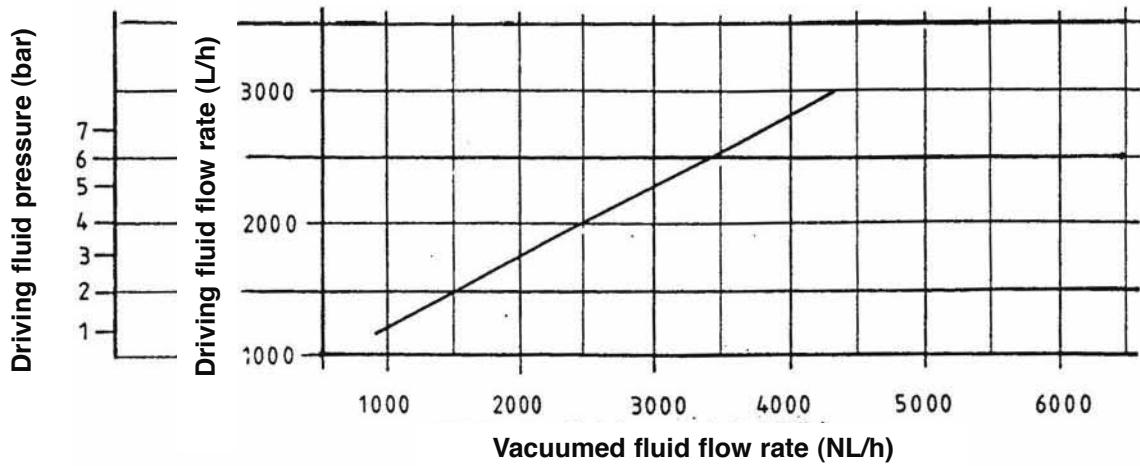

WITH NOZZLE DRILLED BORE Ø 7 mm

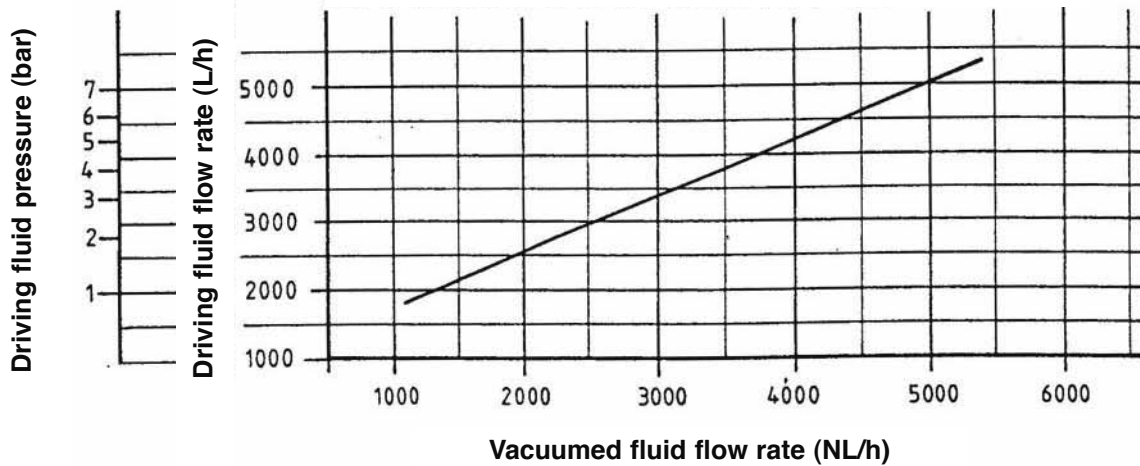

WITH NOZZLE DRILLED BORE Ø 9 mm

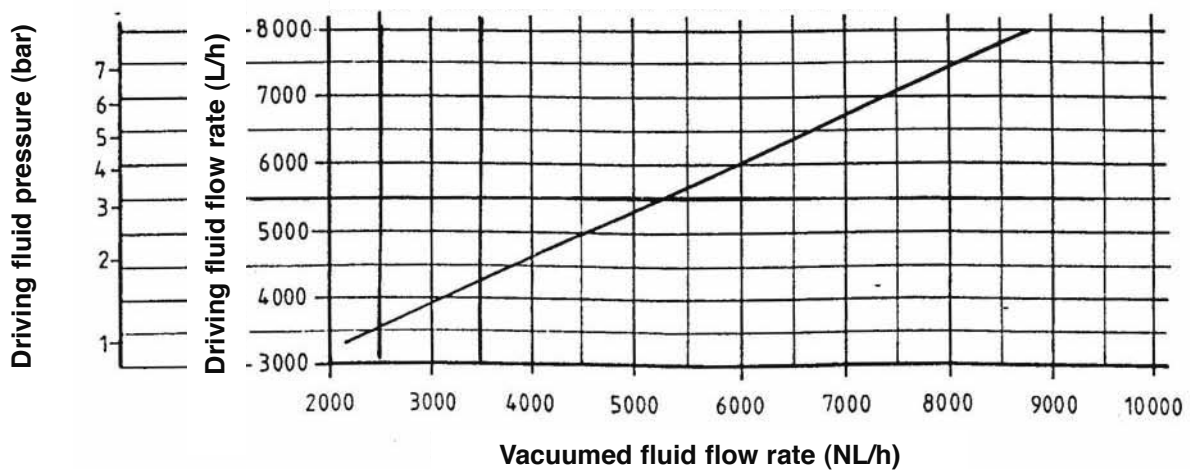

22, Rue de la Voie des Bans - Z.I. de la Gare - 95100 ARGENTEUIL
Tél : (+33) 01 30 25 83 20 - Web : www.bamo.fr
Fax : (+33) 01 34 10 16 05 - E-mail : info@bamo.fr

**Diagrams
for water jet pump
SP 957.50**

02-01-2013

957 M1 02 A

MES

957-02/16

DRIVING FLUID: WATER

VACUUMED FLUID: WATER

WITH NOZZLE DRILLED BORE Ø 6.5 mm

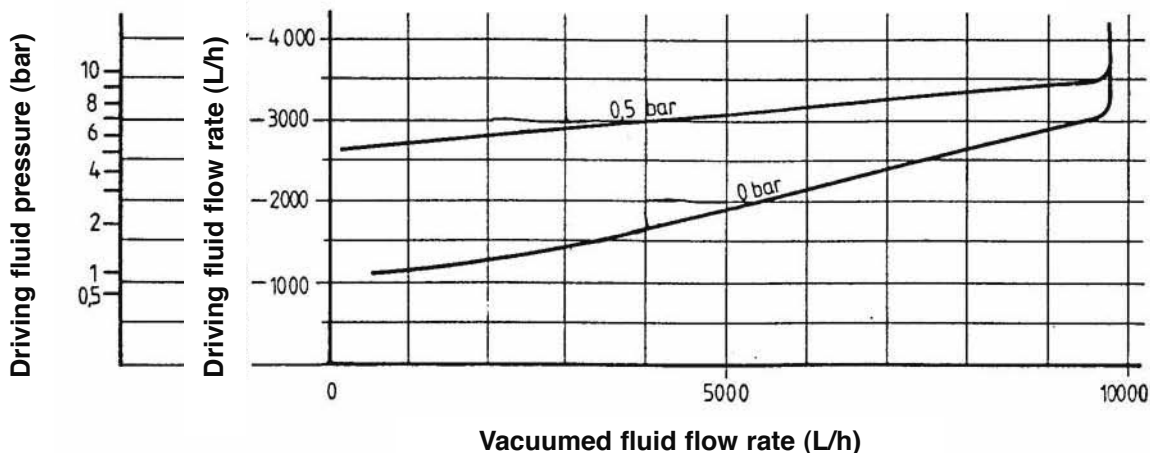

WITH NOZZLE DRILLED BORE Ø 9 mm

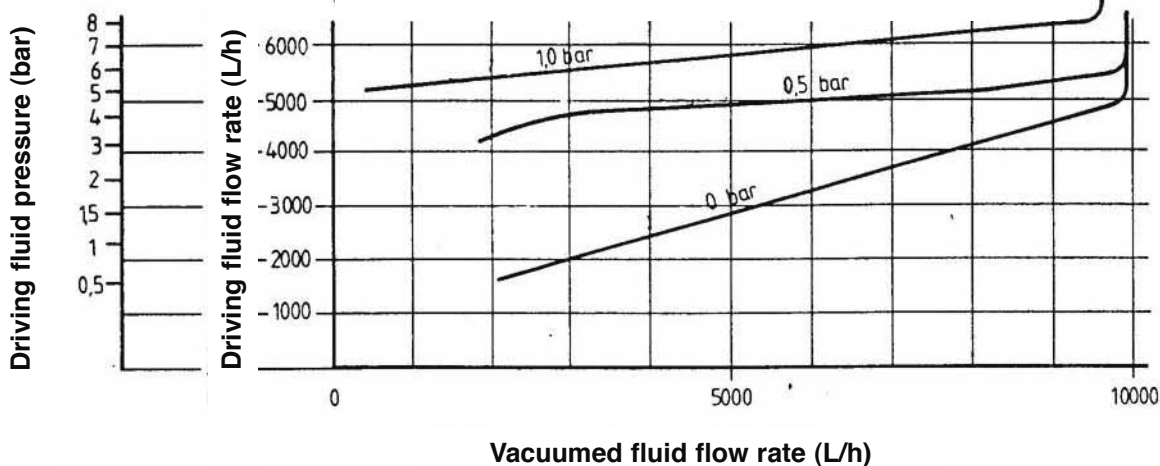

WITH NOZZLE DRILLED BORE Ø 11.5 mm

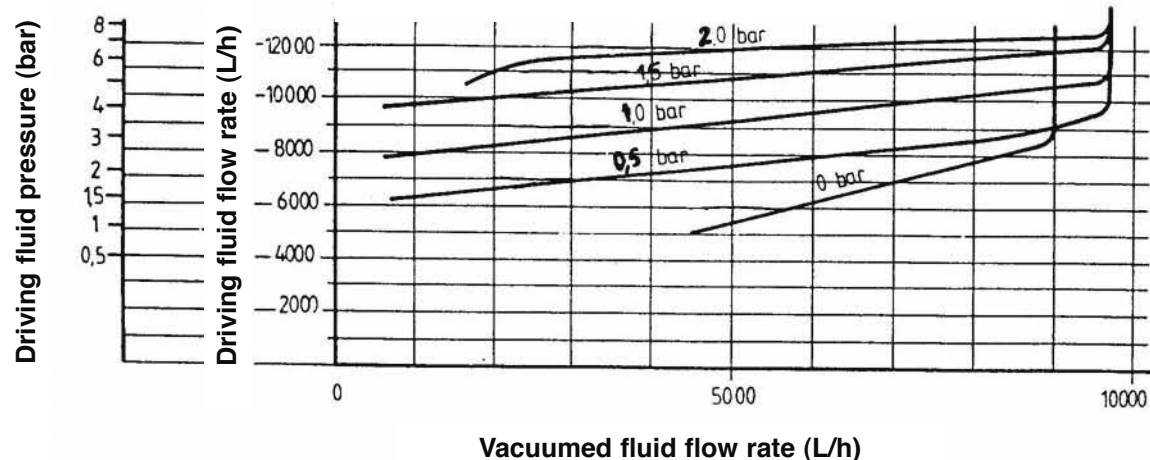

22, Rue de la Voie des Bans - Z.I. de la Gare - 95100 ARGENTEUIL
Tél : (+33) 01 30 25 83 20 - Web : www.bamo.fr
Fax : (+33) 01 34 10 16 05 - E-mail : info@bamo.fr

Diagrams
for water jet pump
SP 957.65

02-01-2013

957 M1 02 A

MES

957-02/17

DRIVING FLUID: WATER

VACUUMED FLUID: AIR

WITH NOZZLE DRILLED BORE Ø 6.5 mm

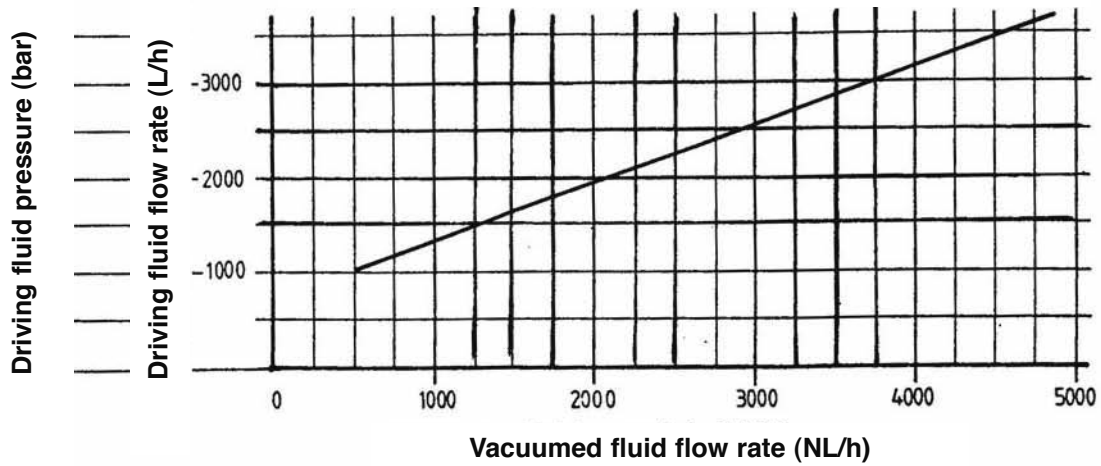

WITH NOZZLE DRILLED BORE Ø 9 mm

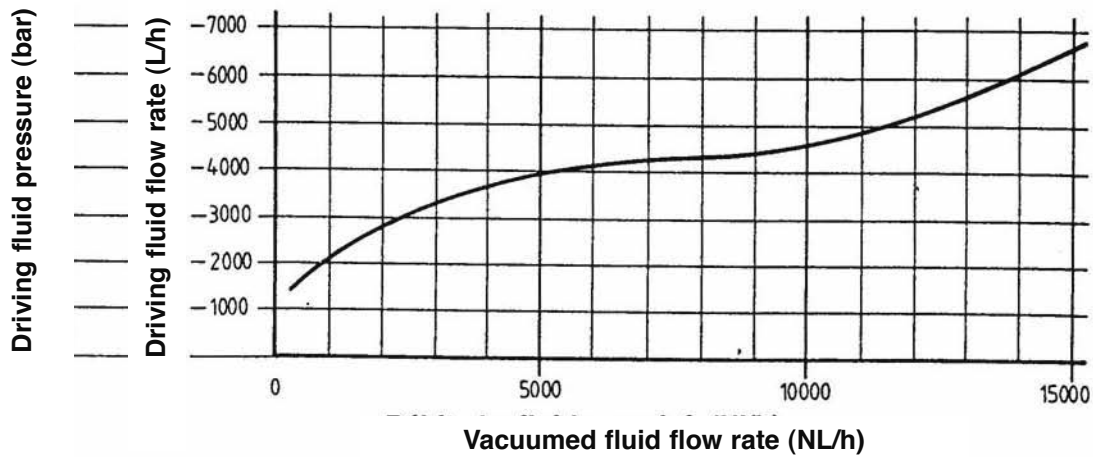

WITH NOZZLE DRILLED BORE Ø 11.5 mm

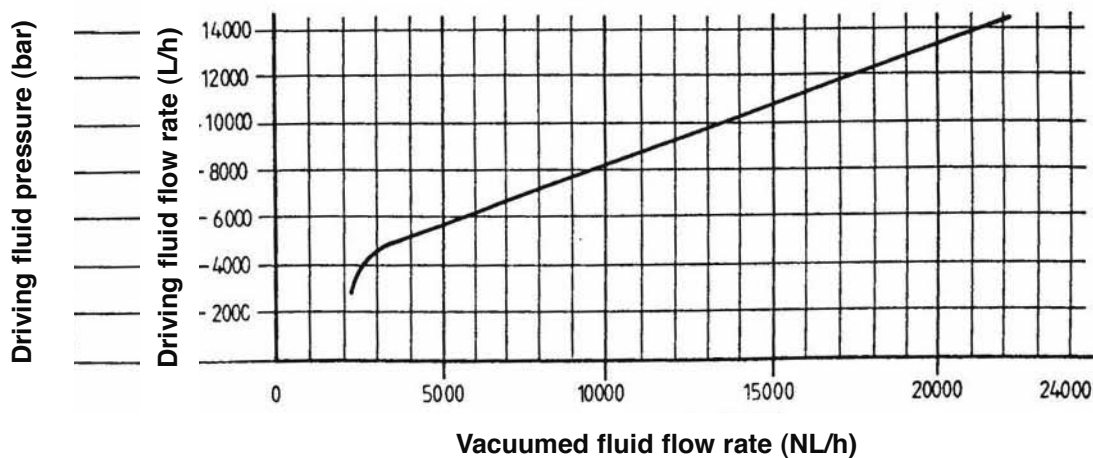

22, Rue de la Voie des Bans - Z.I. de la Gare - 95100 ARGENTEUIL
Tél : (+33) 01 30 25 83 20 - Web : www.bamo.fr
Fax : (+33) 01 34 10 16 05 - E-mail : info@bamo.fr

Diagrams
for water jet pump
SP 957.65

02-01-2013

957 M1 02 A

MES

957-02/18

DRIVING FLUID: WATER

VACUUMED FLUID: WATER

WITH NOZZLE DRILLED BORE Ø 8 mm

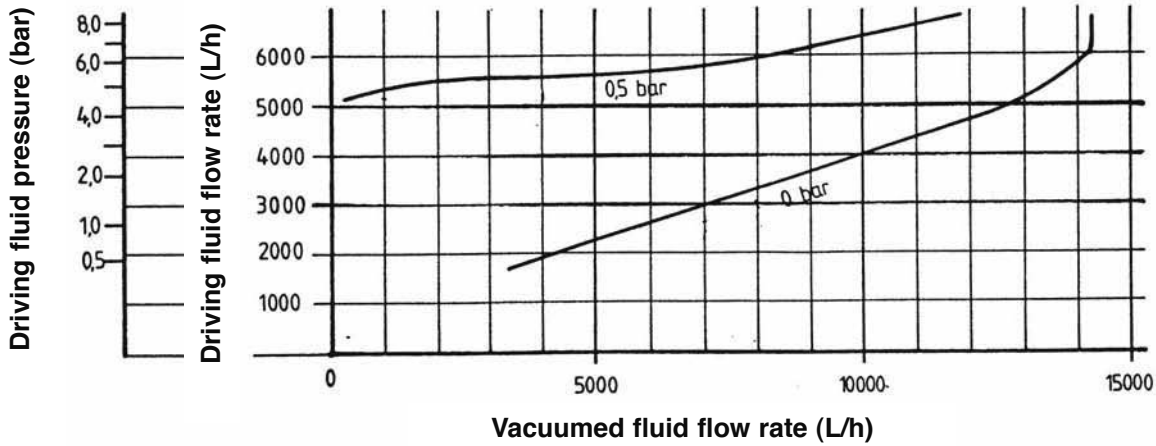

WITH NOZZLE DRILLED BORE Ø 11 mm

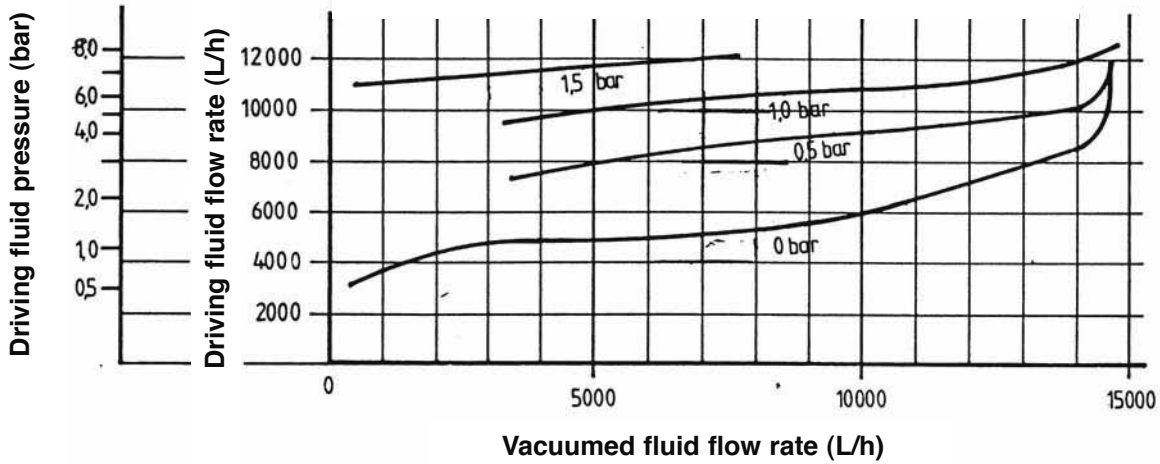

WITH NOZZLE DRILLED BORE Ø 14 mm

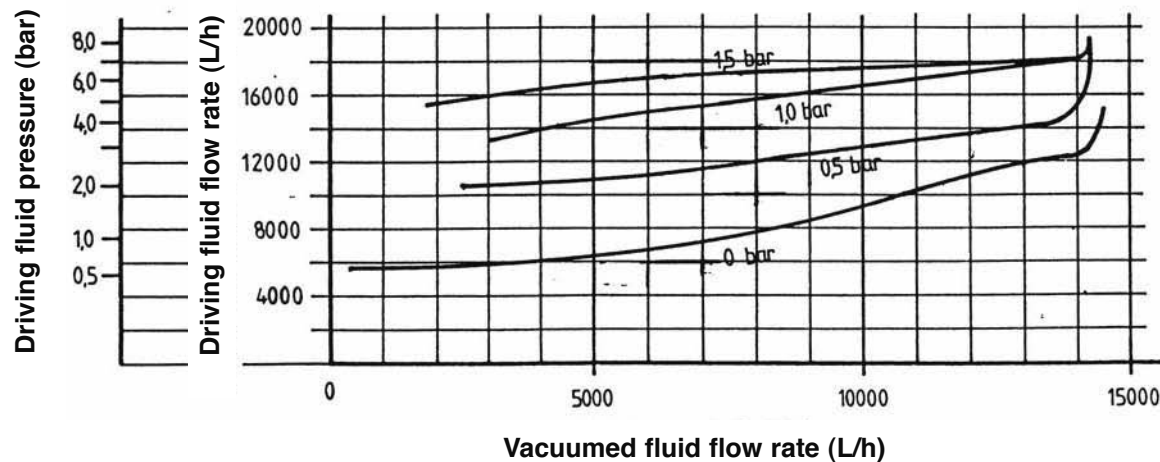

22, Rue de la Voie des Bans - Z.I. de la Gare - 95100 ARGENTEUIL
Tél : (+33) 01 30 25 83 20 - Web : www.bamo.fr
Fax : (+33) 01 34 10 16 05 - E-mail : info@bamo.fr

**Diagrams
for water jet pump
SP 957.80**

02-01-2013

957 M1 02 A

MES

957-02/19

DRIVING FLUID: WATER

VACUUMED FLUID: AIR

WITH NOZZLE DRILLED BORE Ø 8 mm

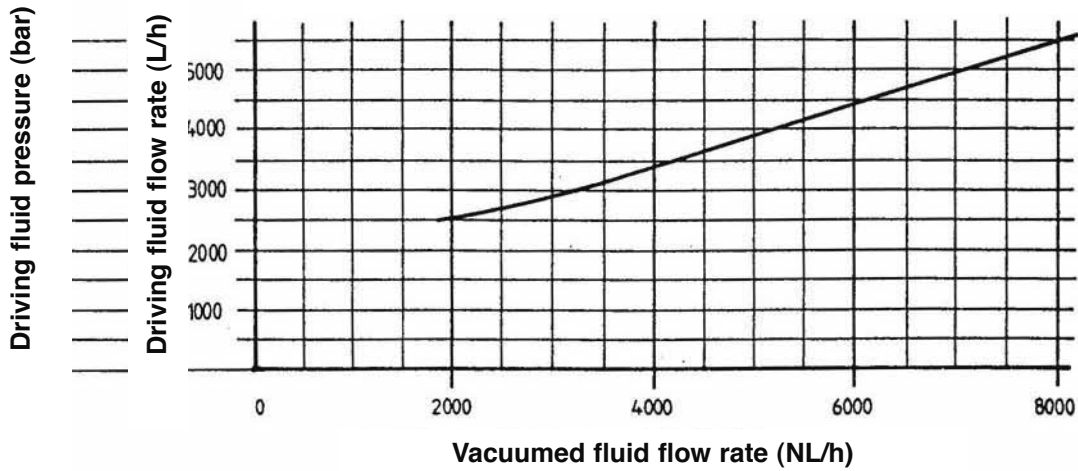

WITH NOZZLE DRILLED BORE Ø 11 mm

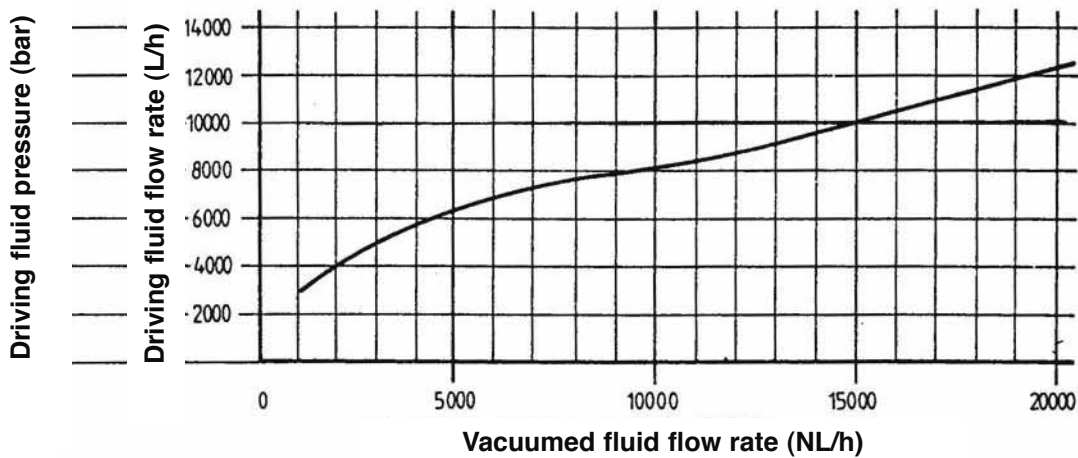

WITH NOZZLE DRILLED BORE Ø 14 mm

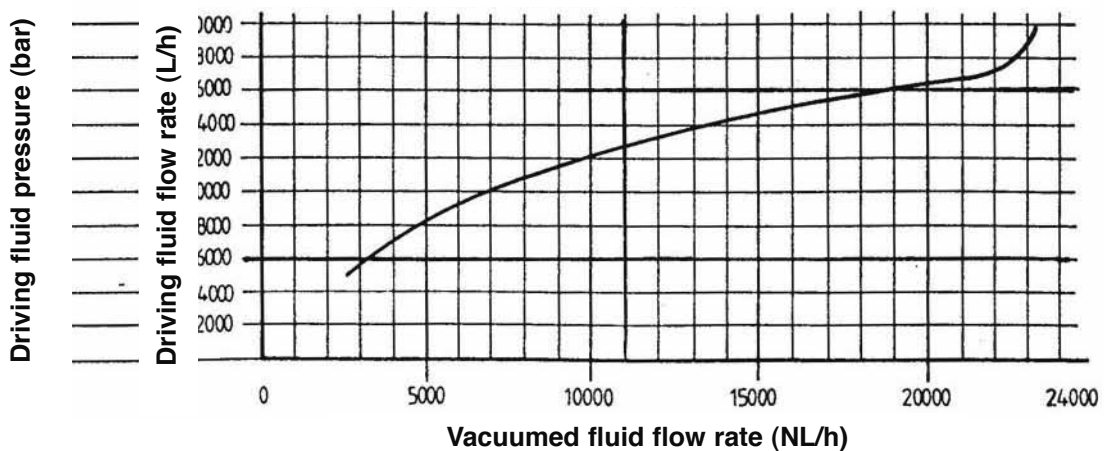

BAMO MESURES

22, Rue de la Voie des Bans - Z.I. de la Gare - 95100 ARGENTEUIL

Tél : (+33) 01 30 25 83 20 - Web : www.bamo.fr

Fax : (+33) 01 34 10 16 05 - E-mail : info@bamo.fr

Diagrams
for water jet pump
SP 957.80

02-01-2013

957 M1 02 A

MES

957-02/20

Vacuum height (m), maxima for SP 957 DN 10 to DN 50

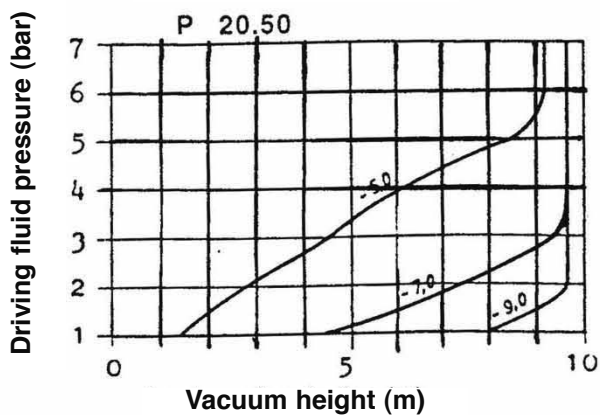
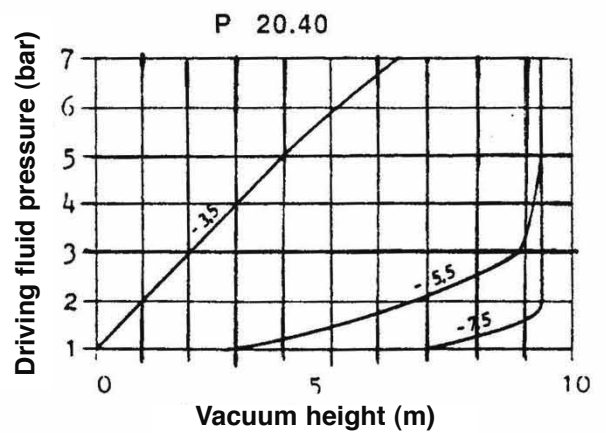
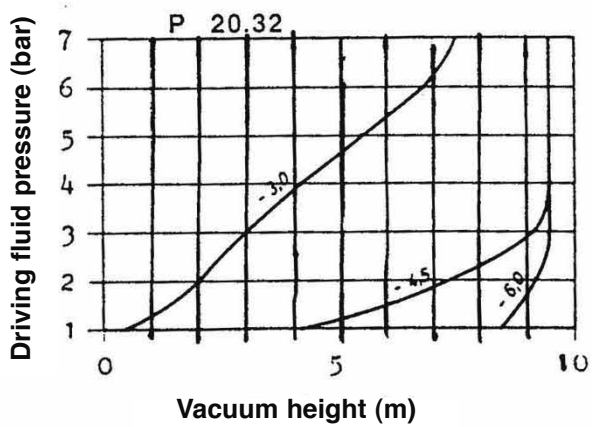
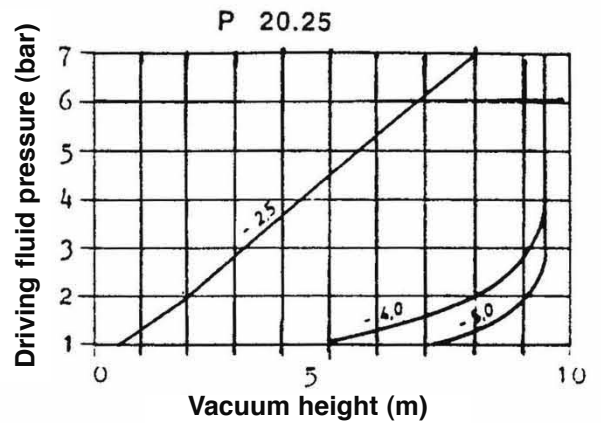
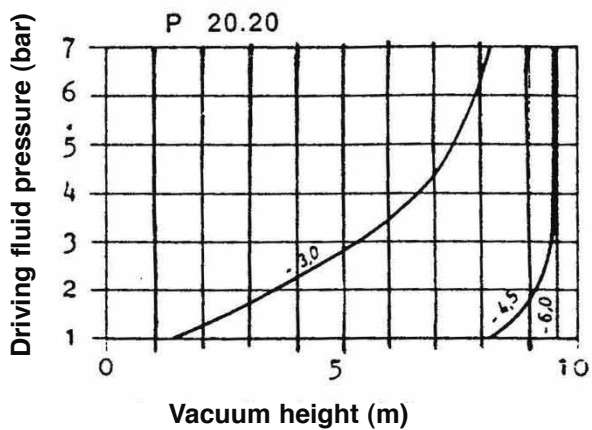
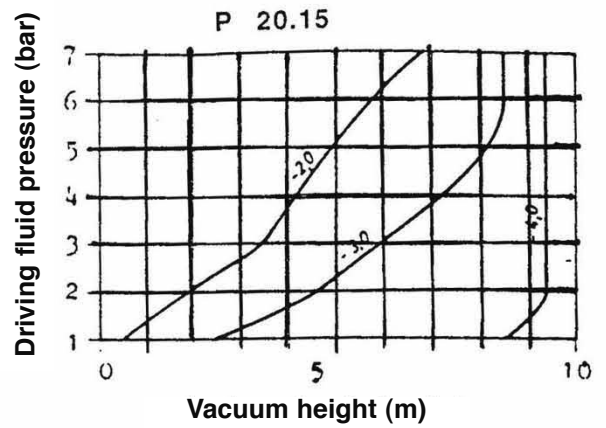
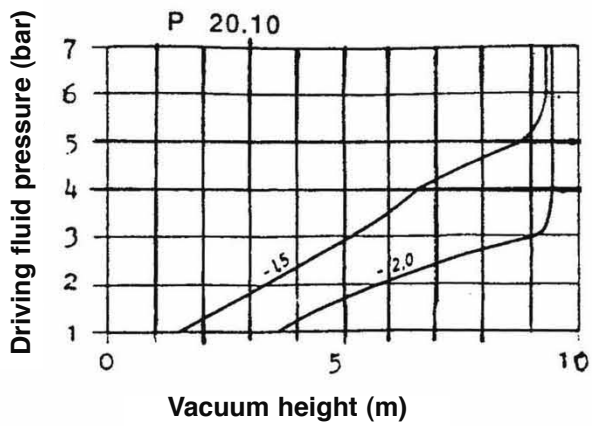

The indication along the curve is the bore drilled diameter in mm

BAMO MESURES

22, Rue de la Voie des Bans - Z.I. de la Gare - 95100 ARGENTEUIL
 Tél : (+33) 01 30 25 83 20 - Web : www.bamo.fr
 Fax : (+33) 01 34 10 16 05 - E-mail : info@bamo.fr

Diagrams
 for water jet pump
SP 957.10...50

02-01-2013

957 M1 02 A

MES

957-02/21

Vacuum height (m), maxima for SP 957 DN 65 and DN 80

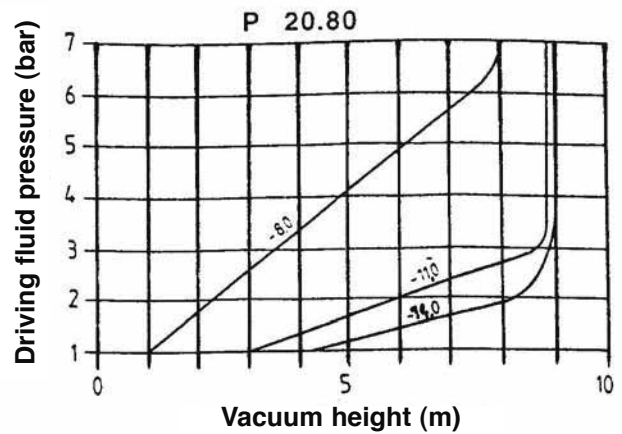
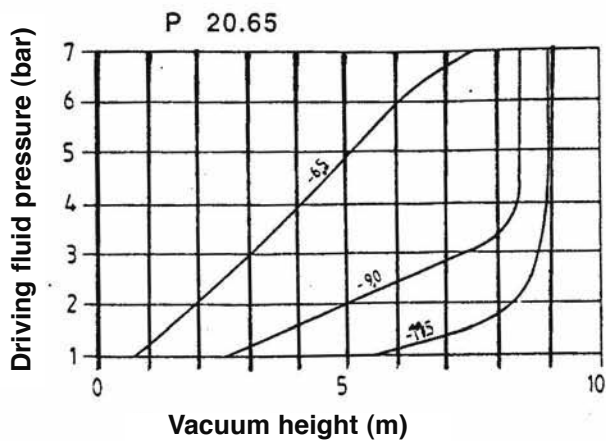

The indication along the curve is the bore drilled diameter in mm

BAMO MESURES

22, Rue de la Voie des Bans - Z.I. de la Gare - 95100 ARGENTEUIL

Tél : (+33) 01 30 25 83 20 - Web : www.bamo.fr

Fax : (+33) 01 34 10 16 05 - E-mail : info@bamo.fr

Diagrams
for water jet pump
SP 957.10...80

02-01-2013

957 M1 02 A

MES

957-02/22