

VE3V S4-PVDF

Electrically actuated ball valves 3-way



INSTRUCTIONS MANUAL

BAMO MESURES

22, Rue de la Voie des Bans - Z.I. de la Gare - 95100 ARGENTEUIL

Tél : (+33) 01 30 25 83 20 - Web : www.bamo.fr

Fax : (+33) 01 34 10 16 05 - E-mail : info@bamo.fr

Electrically actuated
ball valves 3-way
VE3V S4-PVDF

12-11-2013

914 M1 08 C

PLAS

914-08/1

DESCRIPTION

Electric actuators are designed for controlling quarter turn plastic valves. For any other purpose, please report to us before start up; we may not be responsible of troubles due to other applications.

1. Fitting on the pipe line

1.1. Precautions

Before fitting the valve, it is necessary to verify the chemical compatibility between all the elements (*fluid vs. body, seals, seating joints*).

1.2. Assembly

Respect common precautions for the assembly of all elements together.
All parts should correspond in dimensions, pressure & temperature limits.

2. Electric motor connections

2.1. Precautions

- Fitting, connections, initial start-up and maintenance operations must be done by trained technicians.
All European and local rules for electric devices and systems must be respected.
- Follow the recommendations step by step as per following texts, otherwise a correct operation is not warranted.
- Check if the power supply input corresponds to the main power available on site (tag on the electric actuator)
- Do not fit the actuator head down.
- Do not fit the actuator at less than 30 cm from electromagnetic disturbance source.
- Do not wire several actuators on one reversing switch without lines separation
- **Shut off the main power supply before any operation such as:**
 - **Opening the cover**
 - **Unlocking the clutch**
 - **Manual operating for emergency or maintenance**
- The engine was tested on bench before shipment.
Limit switches are adjusted for a rotation of 90° (you may not have to modify this).
- Verify before mounting, the free rotation in place of manual handle (emergency manual override).
- The complete electric actuator is protection class IP65 and no need a specific maintenance.
- **An electric protection must be install (circuit-breaker, etc.) according to the engine power.**

2.2. Wiring and connecting automatism and power circuits

- Connection to earth (ground) is an obligation over 42 V voltage (today standards).
- Connector is DIN 436560 plug, 3 wire + ground

See §5. Electric wiring diagram

2.3. Limit switches (See §5. Electric wiring diagram)

2 limit switches are include in standard and they are set for a 90° rotation.

- Remove the manual emergency override or visual position indicator
- Remove the cover by unscrew the 4 screw
- Loosen the ISO M20 gland to reeve the wire
(ISO M20 gland is useful for 5.5 to 12 mm cable)

Now with the cover remove and the ISO M20 gland loosen you can plug the wires like this:

FC1 →	Connect 4 and 8, NC operation Connect 4 and 5, NO operation
FC2 →	Connect 6 and 9, NC operation Connect 6 and 7, NO operation

- For re-assembling the actuator make this operation in the reverse order

3. Emergency manual override

The priority functioning mode of this actuator is electric. Be sure than the power supply is switched off before using the manual override.

- Turn the knob to position **MAN** (counter-clockwise) and hold it in position.
- Turn the outgoing drive shaft of the actuator with the help of an adjusting spanner.
- In order to re-engage the reduction, release the knob (spring return).

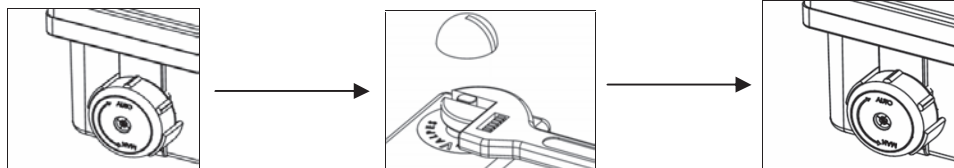

4. Technical data

IP Protection:	IP65 (<i>dusttight, water spraying "flow < 12.5l/min"</i>)
Corrosion resistance: <i>(outdoor and indoor use)</i>	Plastic; PA6.6, ABS, raw material; 304L Stainless or steel + An treatment
Temperature:	-10...+55°C
Hygrometry:	< 80% to 31°C (88 °F) with lineary decrease down to 50% at 40°C (according EN61010-1)
Pollution degree:	Class 2
Altitude:	0 to 2000 m
Operating time:	Around 10 s
Rotation angle:	90°
Manual override:	Out axle
Voltage:	24 V AC/DC 90...240 V AC (90...350 V DC)
Frequency:	50/60 Hz
Power:	15W or 45W
Overvoltage category:	Category II
Torque limiter:	Electric
Duty rating:	30%
Limit switches maximal voltage:	4...250 V AC/DC
Limit switches maximal current:	10mA to 5A max
Electrical wiring:	1 ISO M20 gland, 1 DIN43650 3P+T connector



**Follow the voltage tag
on the actuator**

4. Specifications of 3 ways ball valve

3 ways valves L shape

"L1" fonction: distribution

1 input, 2 output

Start position (0°)

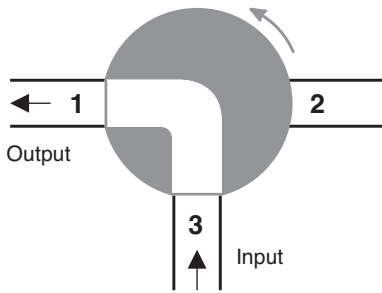

90° Rotation
(clockwise or anticlockwise)

End position (90°)

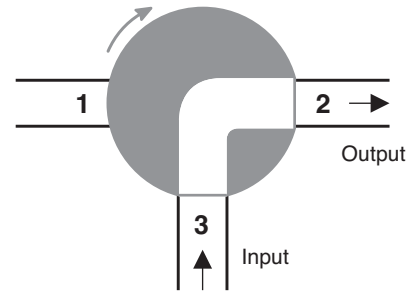

3 ways valves T shape

"T1" fonction: Mixing

2 input, 1 output

Start position (0°)

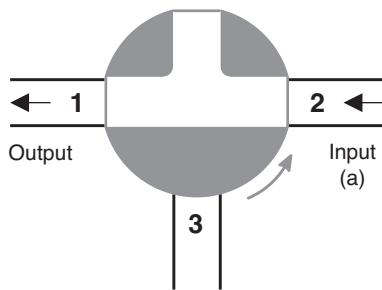

90° Rotation
(clockwise or anticlockwise)

End position (90°)

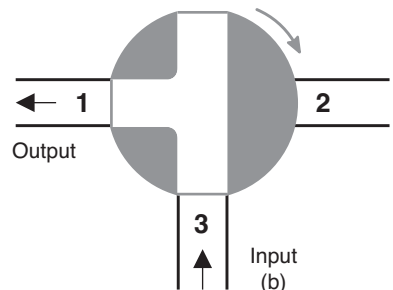

3 ways valves T shape

"T2" fonction: switching

1 input, 2 output

Start position (0°)

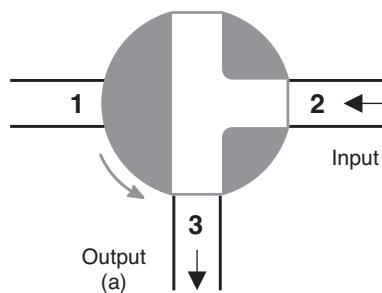

90° Rotation
(clockwise or anticlockwise)

End position (90°)

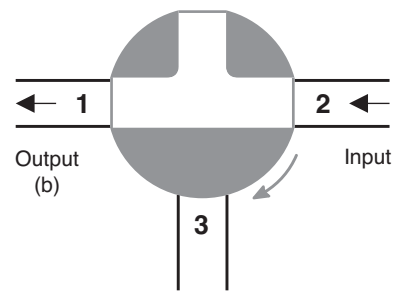

3 ways valves T shape

"T3" fonction: switching

Mode 1: 1 input, 2 output

Mode 2: 1 input, 1 output

Start position (0°)

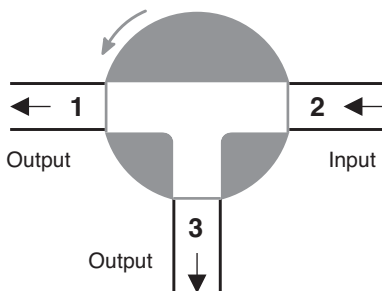

90° Rotation
(clockwise or anticlockwise)

End position (90°)

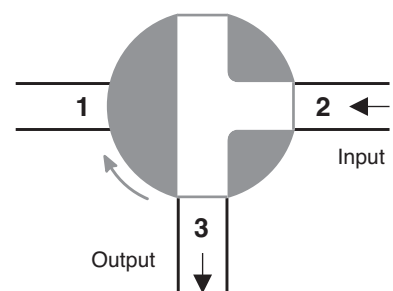

4.1. Exploded view

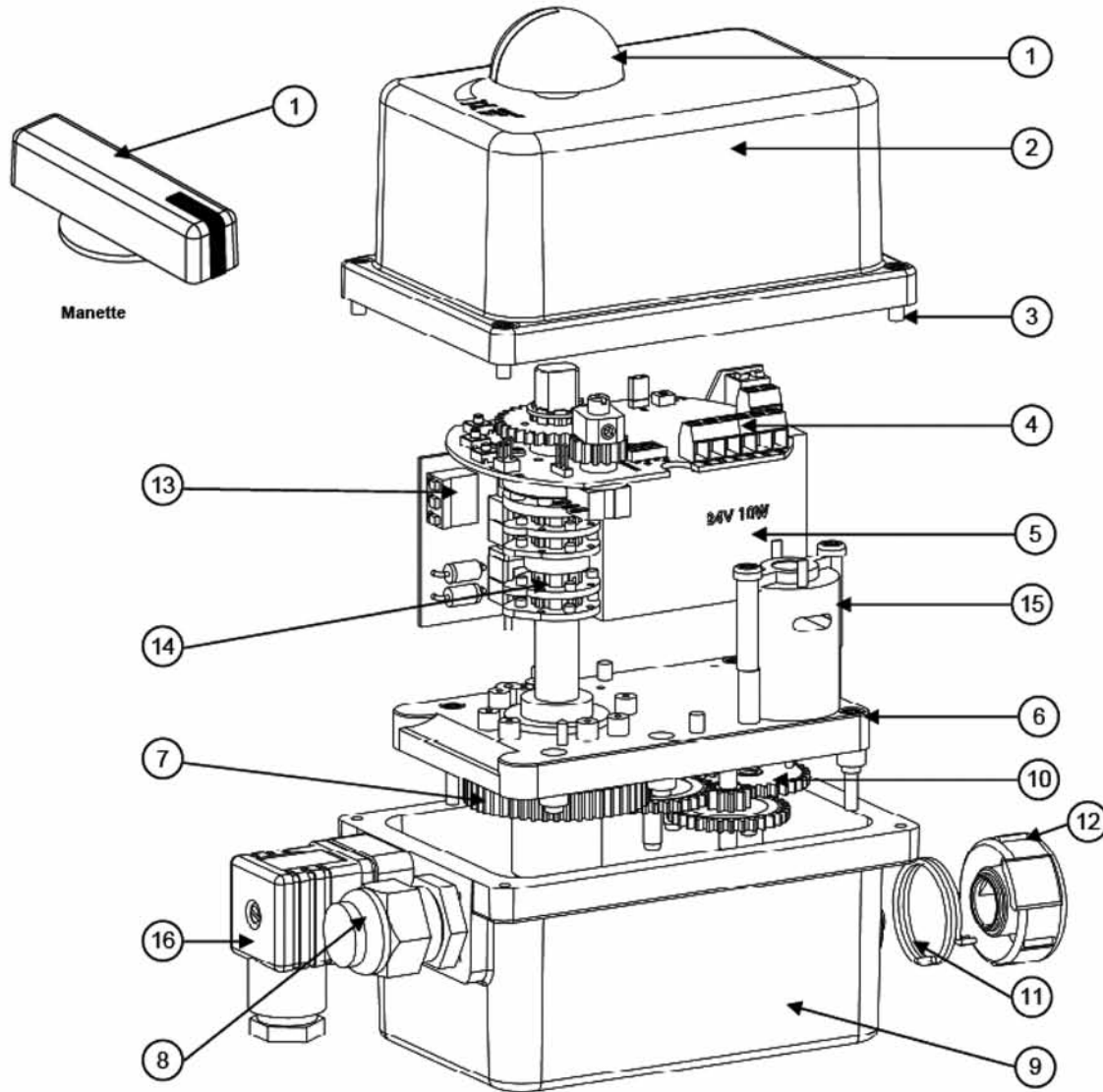

Rep.	Désignation	Designation	Bezeichnung
1	Indicateur visuel de position	Visual position indicator	Stellungsanzeige
2	Capot ABS	ABS cover	ABS Haube
3	Vis inox	Stainless steel screws	Edelstahl Schrauben
4	Bornier signal entrée / sortie	Input / output terminal trip	Anschlussklemmen des Signalgebers / Rückmeldung
5	Carte d'alimentation	Power supply card	Stromversorgung Karte
6	Plaque réducteur	Gear box plate	Getriebeplatte
7	Entraîneur	Shaft + sleeve	Antriebswelle
8	Presse-étoupe ISO M20	ISO M20 gland	PG Schrauben ISO M20
9	Carter Nylon	Nylon housing	Gehäuse
10	Engrenages	Gears	Getriebe
11	Ressort	Spring	Feder
12	Bouton de débrayage	Clutch knob	Schaltknopf
13	Bornier fin de course auxiliaire	Aux. Limit switch terminal trip	Zusätzlicher Endschalter
14	Cames	Cams	Nocken
15	Moteur	Motor	Motor
16	Connecteurs 3P+T (DIN436560)	Connectors 3P+T (DIN436560)	Gerätesteckdosen 3P+T (DIN436560)

5. Electric wiring diagram

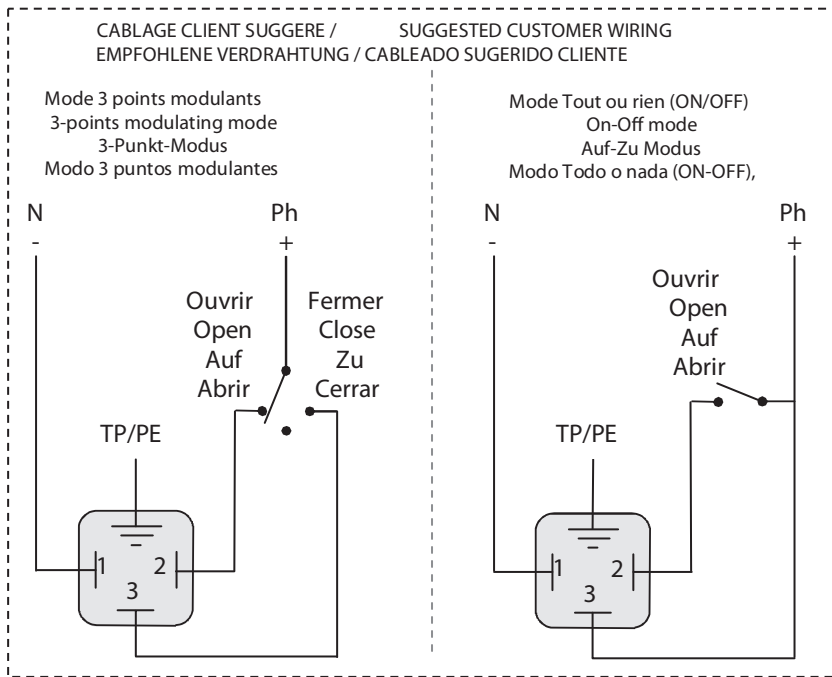

REP	DESIGNATION / DESIGNACIÓN	BESCHREIBUNG
FC0	Fin de course ouverture Open limit switch Endschalter AUF Final de carrera apertura	
FCF	Fin de course fermeture Close limit switch Endschalter ZU Final de carrera cierre	
FC1	Fin de course auxiliaire 1 Auxiliary limit switch 1 Zusätzlicher Endschalter 1 Final de carrera auxiliar 1	
FC2	Fin de course auxiliaire 2 Auxiliary limit switch 2 Zusätzlicher Endschalter 2 Final de carrera auxiliar 2	
D1/D2	Bornier report défaut (24V DC / 3A max) Failure report Terminal strip (24V DC / 3A max) Fehlermeldung Klemmleiste (24V DC / 3A max) Terminal retorno de defecto (24V DC / 3A max)	

RECOPIE / FEEDBACK
RÜCKMELDUNG

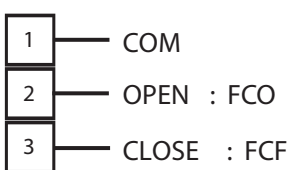
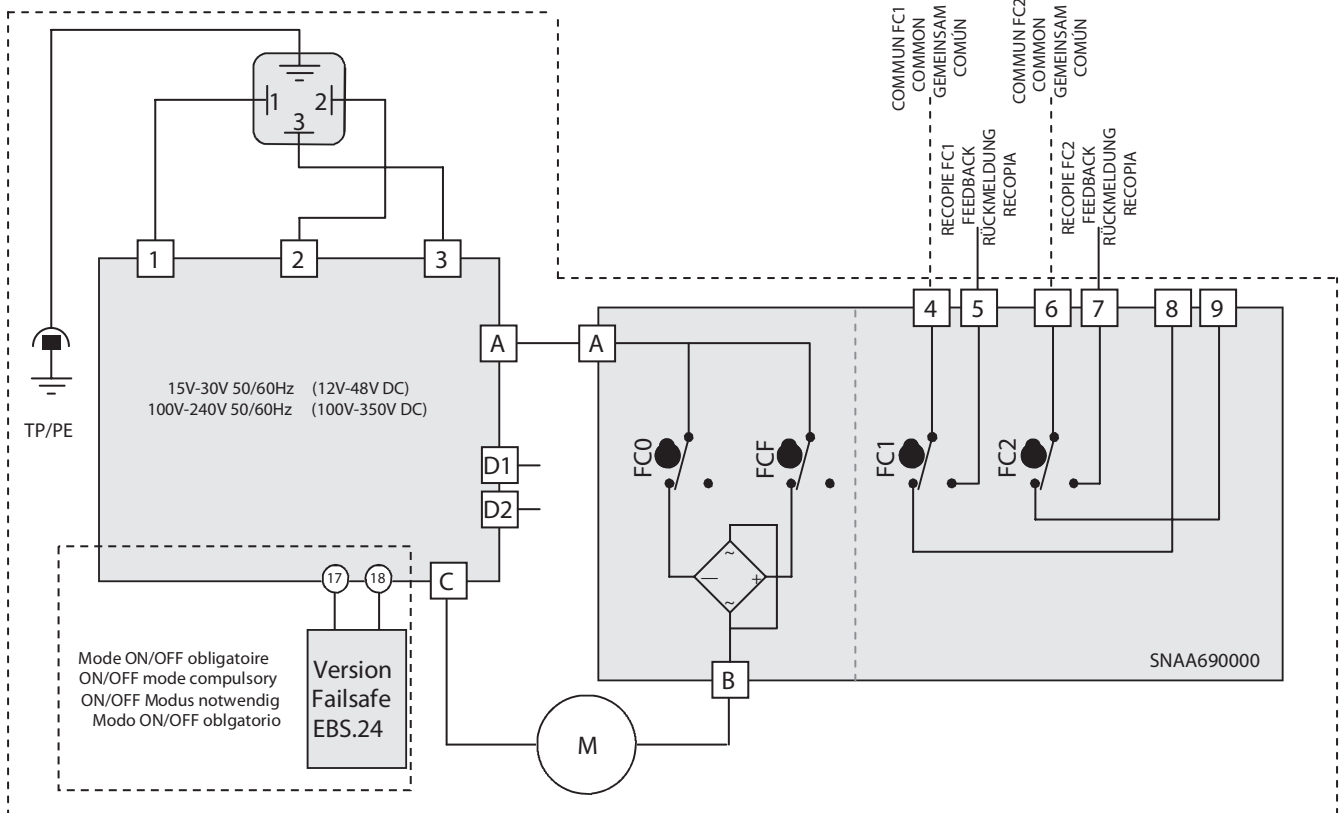

ALIMENTATION
POWER
SUPPLY
SPANUNGSVER-
SORGUNG
ALIMENTACIÓN

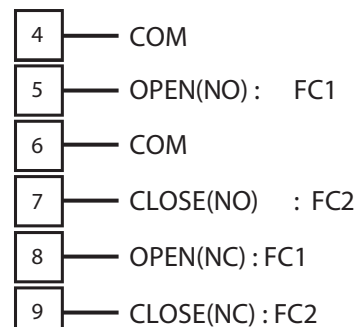

FINS DE COURSE
LIMIT SWITCH
OUTPUT
RÜCKMELDUNG
RECOPIA

La température du bornier peut atteindre 90°C
The terminal temperature can reach 90°C
Die Terminal-Temperatur kann bis zu 90°C erreichen.
La temperatura del Terminal de conexión puede alcanzar 90°C

6. Open / close position

Position fermée
Close position

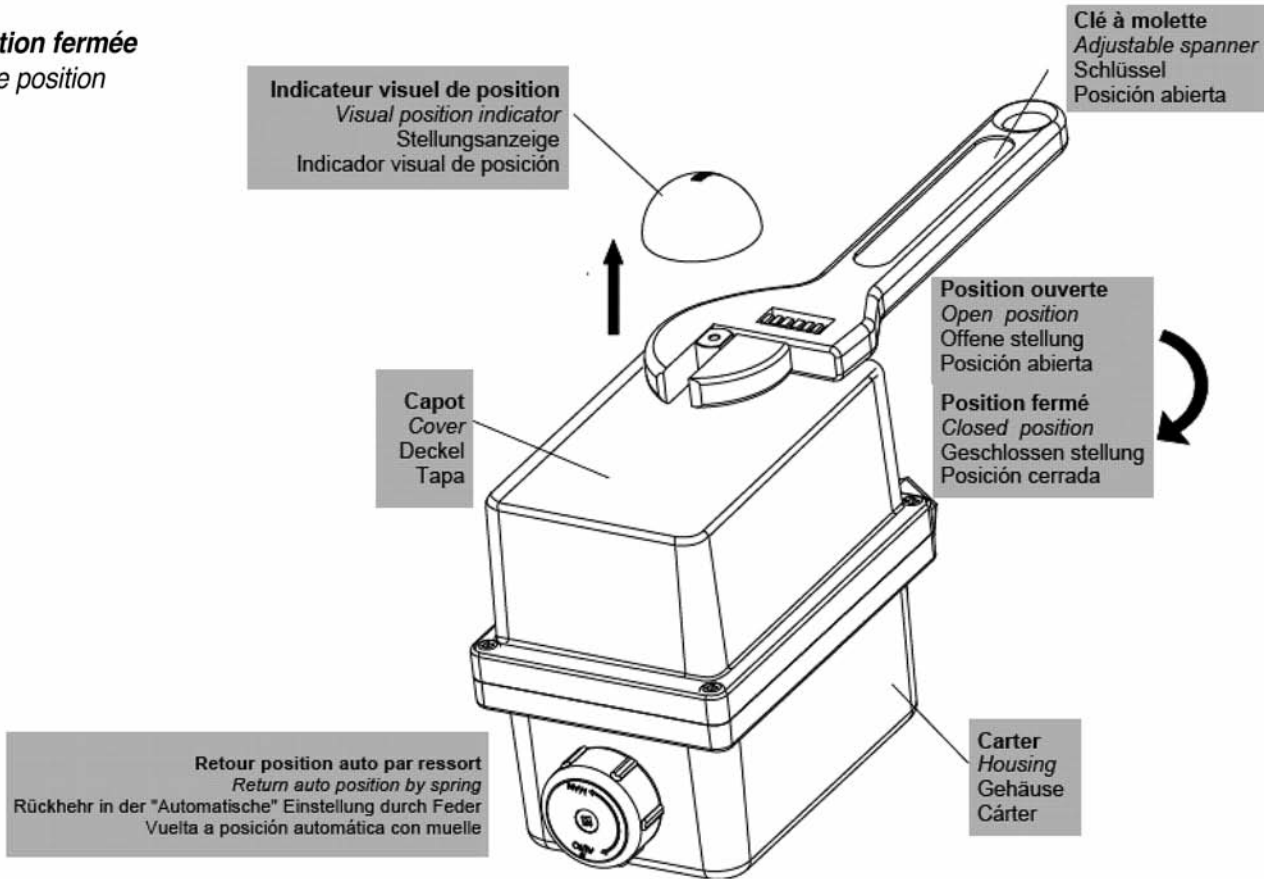

Position ouverte
Open position

