

# TRUBOMAT® GAB 1000

**In-line turbidity transmitter**  
**From 0.1 to 1000 FNU**



## INSTRUCTIONS MANUAL

**BAMO MESURES**

22, Rue de la Voie des Bans - Z.I. de la Gare - 95100 ARGENTEUIL

Tél : (+33) 01 30 25 83 20 - Web : [www.bamo.fr](http://www.bamo.fr)

Fax : (+33) 01 34 10 16 05 - E-mail : [info@bamo.fr](mailto:info@bamo.fr)

In-line turbidity transmitter  
**TRUBOMAT® GAB 1000**

12-03-2015

446 M1 02 G

**MES**

**446-02/1**

## SAFETY PRECAUTIONS

Only qualified person should operate, install and assure the maintenance.  
All International and European recommendations on electrical installation should be applied.

- The device may only be connected to supply power, which complies with the specifications included in the technical data.
- The device must be disconnected from all sources of power during installation and maintenance work.
- The device may only be operated under the conditions specified in the operating instructions.

## FUNCTIONS - DESCRIPTION

The turbidity-measuring device determines the turbidity of liquids using the light absorption and scattered light measuring method. The inline measuring cell at the sensor set makes use of two IR transmitters and one IR receiver in pulsating light mode (IR measuring method according to ISO 7027). The interconnected BAMOPHOX TUR measuring amplifier (option) analyses the 4 to 20 mA signal generated by the sensor set.

## MOUNTING

- The fixture must be installed **vertically**. – Best installation is the mounting in an ascending pipe with slow down section 600 mm in front and 400 mm behind the turbidity-measuring device.
- The sensor fixture must be completely filled with liquid during the performance of measurements.  
Install to the vertical portion of a siphon trap if necessary.
- Air bubbles distort measurement results.
- Glass windows must be clean – clean them at regular intervals as required.

## SET UP – DISPLAYS

The sensor set consists of a receiver module with microprocessor-controlled analysis electronics and two emitter modules. The sensor set generates a 4 to 20 mA output signal in accordance with the following diagram. Measuring ranges are selected with the help of the DIP switches on the receiver module.

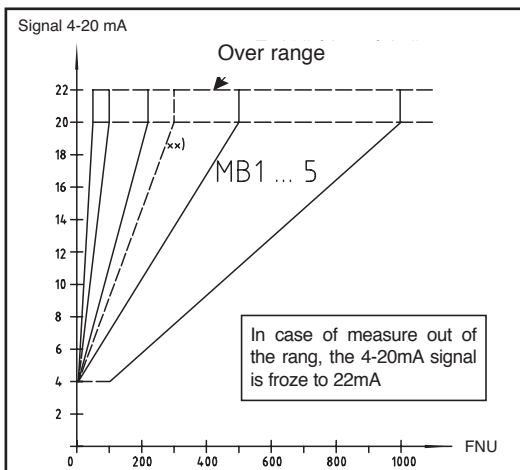

**Note:** The turbidity measuring instruments are calibrated with the internationally specified standard suspension Formazin.

The indication takes place thus not in form of the measured light intensity, but as concentration of the Formazin calibration suspension.

During the measurement with any liquid, this means thus that the liquid concerned causes the same light scattering as the standard suspension of the indicated concentration.

Measured values of other turbidity measuring instruments, which use other calibration suspensions and measuring angle, cannot be compared directly with those with Formazin calibrated measuring instruments.

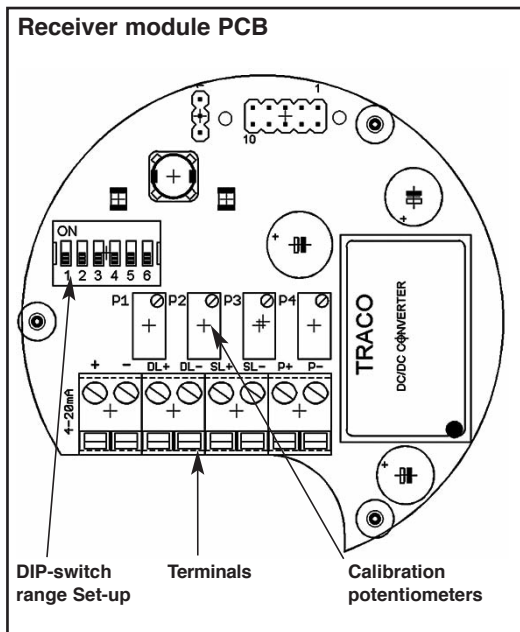

Measuring range	DIP1	DIP2	DIP3	DIP4	DIP5*	DIP6*
MB1 = 0.1... 50 FNU	OFF	OFF	OFF	ON	NC	NC
MB2 = 0.1...100 FNU	ON	OFF	OFF	ON	NC	NC
MB3 = 0.1...200 FNU	OFF	ON	OFF	ON	NC	NC
MB4 = 0.1...500 FNU (**300)	ON	ON	OFF	ON	NC	NC
MB5 = 100...1000 FNU	OFF	OFF	OFF	OFF	NC	NC

\* ) DIP5 and 6 = not connected / no function  
\*\* ) Armatures with nominal diameter > DN 65

	Indication
Green LED = 1Hz blinking	Ready, measuring in operation
Green LED = permanent ON	Ready, measuring not in operation
Green LED = OFF	No power supply, or defective

	Fault indication
Red LED = ON	Measuring circuit faulty, (short circuit, or broken) (court circuit ou rupture)

**Signal in limit conditions:**

- 0 mA = wrong connected and / or dip-switches wrong adjusted
- 4 mA = 0 FNU (clearest water, pipe filled)
- 20 mA = 100% output acc. to adjusted range (pipe filled)
- 22 mA = over range
- 21 mA = general failure on electronics

**When pipe is empty:** If there are no water drops on the glasses the output will be a little bit higher than 4 mA (depending on the refraction index of air-molecules). If there are water drops on the glasses the output is higher than 4 mA, but the signal depends on size and quantity of water drops.

**So it's important to install the turbidity measurement system always in such a way that the pipe is filled at any time (vertically or with a siphon). That's valid not only for TURBICUBE but for all systems on the market.**

## 5 WIRING

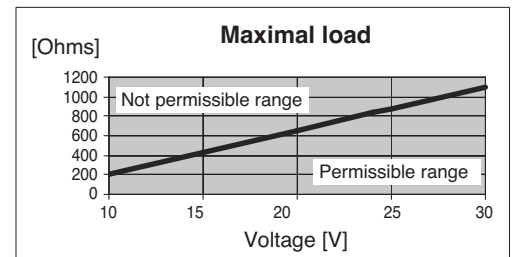
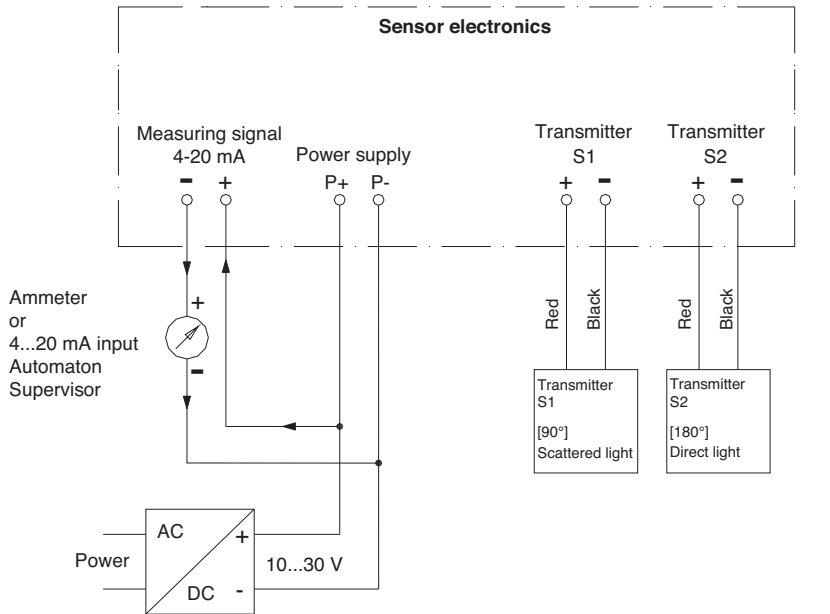

**NOTE:** The measuring output "4-20 mA" is a current drain, this means, the output channel has the same electrical behaviour as a variable resistor. An active power supply for the measuring circuit is always needed.

For connection to BAMOPHOX TUR, please see specific documentation msa436-01.

## 6 TECHNICAL FEATURES

Power supply: 24 V DC rated (10...30 V DC)  
 Power consumption: 0,5 W  
 Output signal: 4-20 mA, for connection to the BAMOPHOX TUR 436  
 Ambient temperature: +5...+45 °C  
 Process temperature: +5...+100 °C  
 Material: 316L Stainless steel body / Terminal housing plastic PBT, IP 65  
 Accuracy: ±5% reading, ±1% full scale in use  
 Resolution: 0,001...0,2 FNU according to measuring range

Measuring ranges	ND 25...ND65 :	0.1...50 FNU	0.1...100 FNU	0.1...200 FNU	0.1...500 FNU	100...1000 FAU
	ND 80...ND 100 :	0.1...50 FNU	0.1...100 FNU	0.1...200 FNU	0.1...300 FNU	100...1000 FAU

Process connections (ND25...ND 100): PN10 flanges (DIN 2633), Triclamp (DIN 11850)

ND	L: Flanges DIN 2633	L: Triclamp DIN 11850
ND 25	274	288
ND 32	252	266
ND 40	230	244
ND 50	190	202
ND 65	233	249
ND 80	208	218
ND 100	240	260

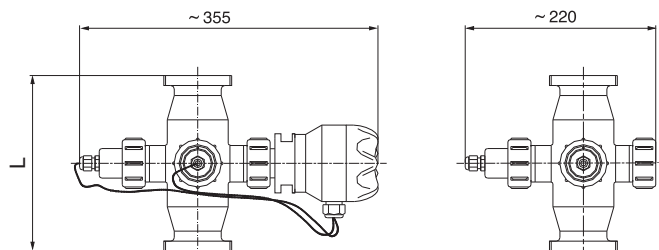

**CE Mark:** In accordance with low-voltage directive (2006/95/EG), EMC directives (2004/108/CEE)

## 7 MAINTENANCE

Cleaning intervals depend upon the type of liquid medium and must be determined by the user.

### Cleaning the lenses:

- Disconnect the turbidity-measuring instrument from all sources of power.
- Depressurize pipes and empty liquid medium from the device.
- Remove the transmitters and the receiver from the fixture by unscrewing the sleeve nuts.

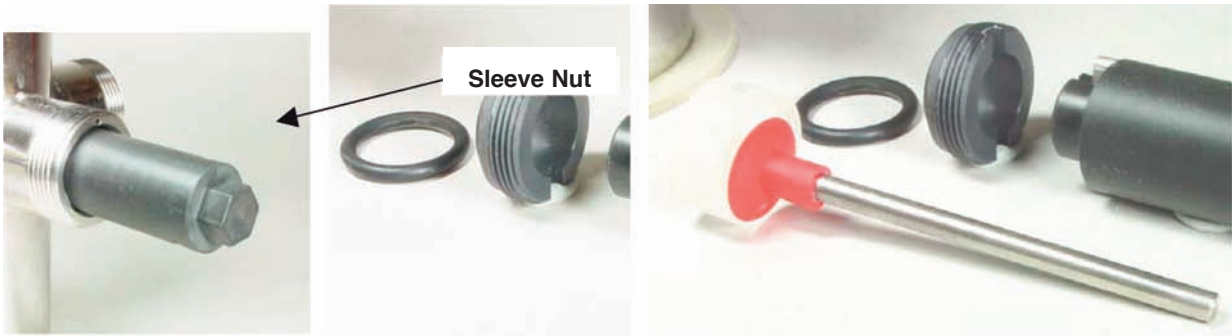

1) Screw the compression disc with the included tool and remove it.

2) Remove the O-ring.

3) Remove the lens with the included suction cup, and clean the lens.  
**Do not use abrasive cleansers**

Reassemble after cleaning by following the above instructions in reverse.

### **Note:**

- Inspect the O-ring before reassembly and replace it if necessary.
- Tighten the compression disc with the included tool (use the rod of the suction cup as a lever).
- Before reinstalling the transmitters and the receiver, refill the fixture with liquid medium and inspect for possible leaks.

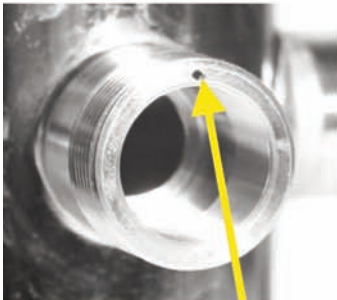

**Observe the positioning of hole and pin.**

This side has a dirt repellent coating. This side must face the medium after the lens has been mounted.

**Observe the point**

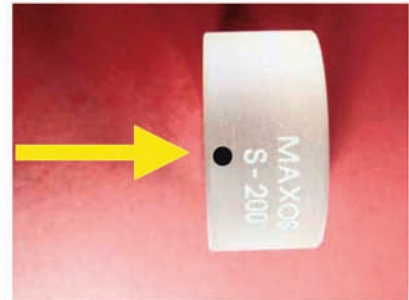

Observe above note if coated lenses are used.

### **Note for cold fluids:**

- The fixture has to be installed on the piping with mounted sensors only.
- To clean the glasses, dismount the complete fixture. After cleaning install as described above.