

CC1

**Sensor for measuring Free chlorine
with isocyanuric acid**



INSTRUCTIONS MANUAL

BAMO MESURES

22, Rue de la Voie des Bans - Z.I. de la Gare - 95100 ARGENTEUIL

Tél : (+33) 01 30 25 83 20 - Web : www.bamo.fr

Fax : (+33) 01 34 10 16 05 - E-mail : info@bamo.fr

**AMPEROMETRIC SENSOR
CC1**

04-01-2012

193 M1 06 B

MES

193-06/1

PARAMETER	Synonymous	Components	Chemical formula	EVALUATION
Potential chlorine		Hypochlorite ions Chloro-cyanurates	OCI^- ClCy	Difference between free chlorine and active chlorine concentrations
Active chlorine	Free active chlorine	Elementary chlorine Hypochlorous acid	Cl_2 HOCl	According to pH and chlorine percentage (see dissociation curve)
Free chlorine	Total free chlorine	Elementary chlorine Hypochlorous acid Hypochlorites	Cl_2 HOCl OCI^-	BAMO kits or meters using DPD1
Combined chlorine	Chloramines (organic compounds under destruction)	Monochloramine Dichloramine Trichloramine	NH_2Cl NHCl_2 NCl_3	Difference between free chlorine and total chlorine concentrations
Total chlorine		Elementary Chlorine Hypochlorous Acid Hypochlorites Dichloramine	Cl_2 HOCl OCI^- NHCl_2	BAMO kits or meters using DPD4 (or 1+3)
Chlorides	Inert chloride Reduced chloride	Chlorides	NaCl CaCl_2	
Stabilizer		Isocyanuric acid		

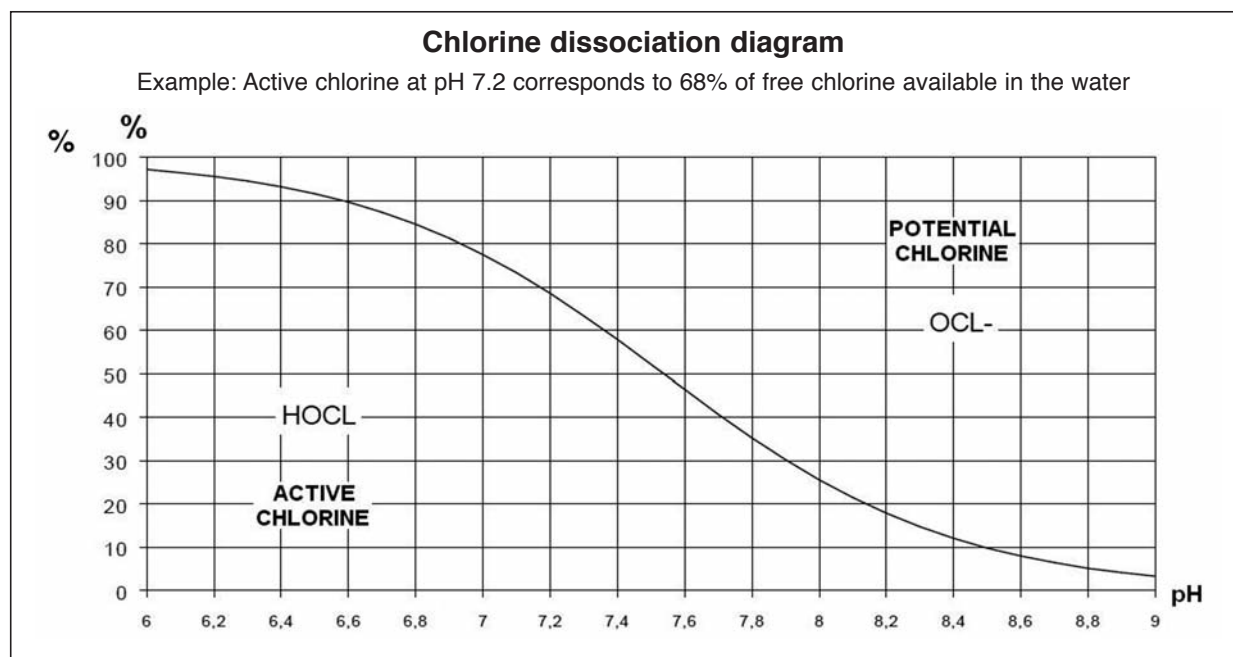

1. SENSOR CC1, PRINCIPLE

The Amperometric sensor CC1 is a closed cell type. The measuring elements are separated from the fluid by a specific diaphragm. Chlorine is allowed to pass through it and is reduced on the cathode. The induced current is proportional to chlorine concentration. Surfactants may not be present in the sample.

- The sensor is free from zero calibration

- **Transmitter and sensor must be energized at anytime.** Do not shut off the 2 wire powered loop, keep the monitor turned on all the time

2. FEATURES

2.1 Technical features

Range:	0.01 to 10 ppm (free chlorine with iso-cyanuric acid) – independent from pH
Operating pH range:	From 4 to 12 pH
Power supply:	2 wire technique, 12 ... 30 V DC, [R _{max} = (U-7,5) / 20 kOhm]
	Cross section 0.25 mm ²
Pressure limit:	0.5 bar as a maximum
Temperature limits:	From 1 to 45°C
Flow rate limits:	From 30 to 40 L/h
Materials:	PVC-U, AISI 316 L electro-polished
Dimensions:	Ø 25 mm, length 225 mm

CAUTION: The sample may not content surfactants

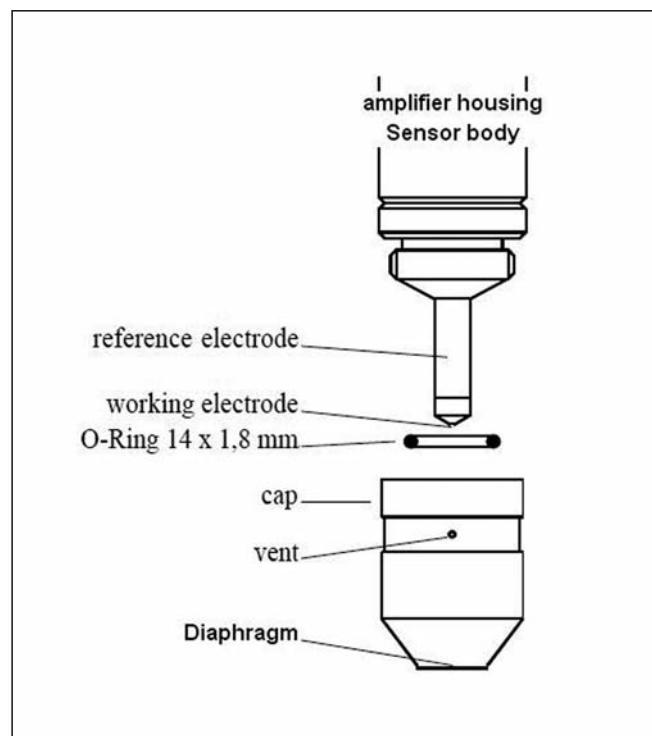
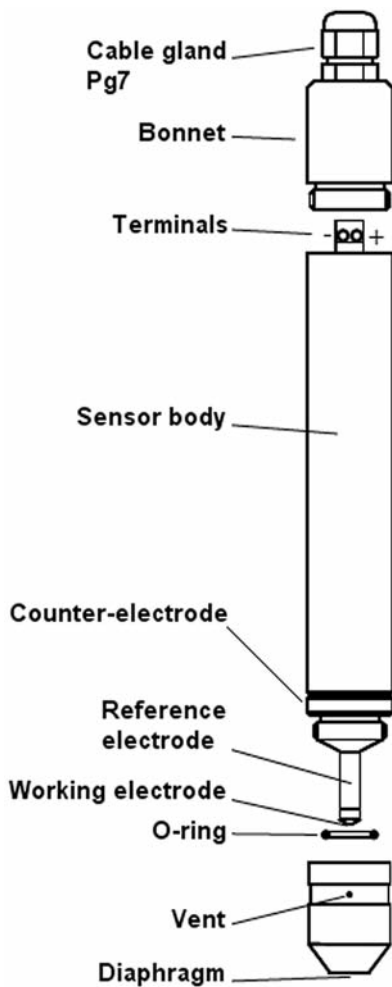

2.2 Code numbers and reference

Code	Reference	Range
193 063	CC1.MA2	0.01 to 2 ppm
193 064	CC1.MA5	0.01 to 5 ppm
193 065	CC1.MA10	0.01 to 10 ppm



Replacement parts

Code	Reference	Designation
193 903	M48	Sensor end with diaphragm for CC1 or CP2.1
193 954	ECC 1/G	Electrolyte for CC1 (100 mL flask)

3. TYPICAL MEASURING SYSTEM

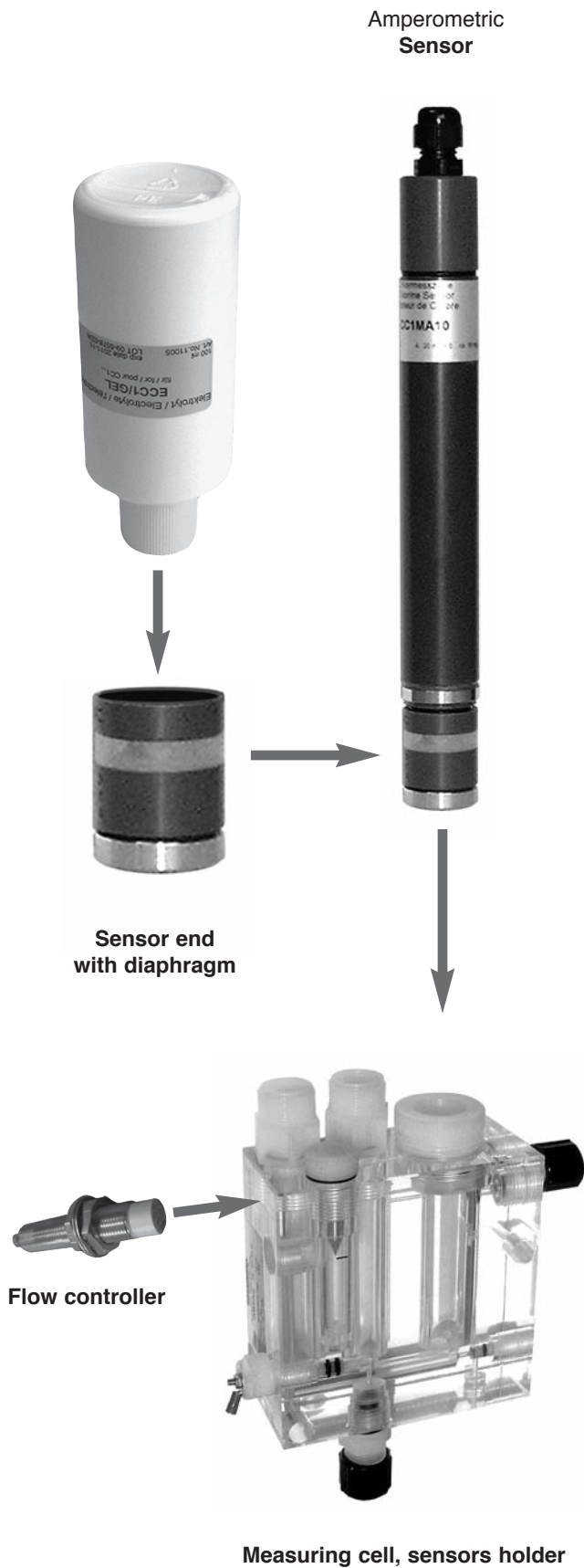

Monitor
Example: BAMOPHOX 194

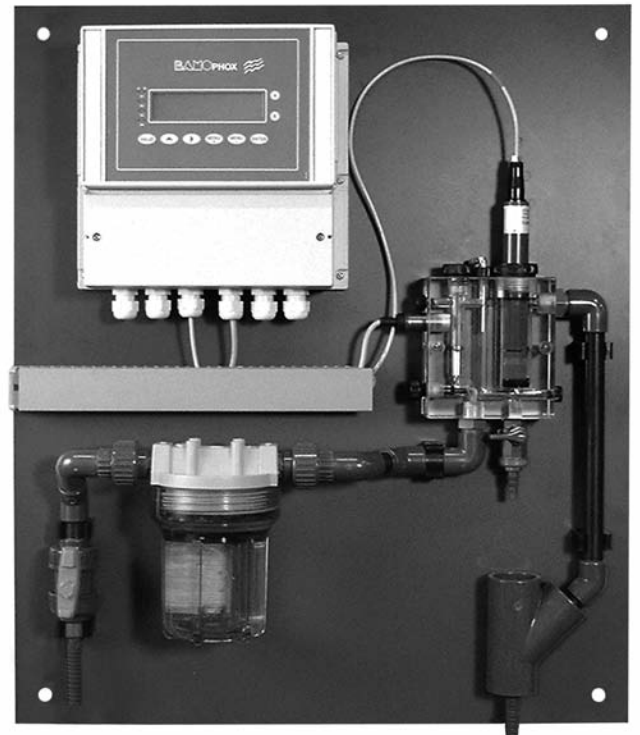

Example of a complete assembly

4. PREPARING THE SENSOR



The electrodes must not be touched with fingers
Do not remove the coating on the electrode



a/ Filling the sensor end

- Unscrew the sensor end from the sensor body.
- Place it onto a clean base.
- Fill up the sensor end up to the edge with electrolyte.
Some electrolytes contain diluted acids. Respect the warnings on the electrolyte bottle.
- Be careful there are no bubbles in the electrolyte (occurring particularly with gel electrolyte).
Keep the electrolyte flask well tapped and upside down, head below (gel electrolyte).



b/ Screwing the sensor end on the sensor body

- Hold the sensor body upright and put it on the sensor end.
- Turn the body anticlockwise, until you hear the noise of thread engaged.
- Then screw slowly the sensor body clockwise (by hand) onto the sensor end.
Exceeding electrolyte will escape through a vent hole (see the arrow)
- Never close this vent hole with your finger.
Never presses the sealing tape (see the picture).



c/ Checking up the sensor

- Check whether the sensor end is completely screwed in up to the stop.
- The first screw-in resistance comes from the O-ring seal.
However the screwing procedure of the cap must be continued until it hits the adapter!
- When the sensor end has been screwed on, the diaphragm is curved to the outside and must not be thumped, as this will damage it and make it unusable.
- Wash up the excess electrolyte with water.

5. FITTING THE SENSOR IN MEASURING CELL

Amperometric sensors are usually fitted in a specific measuring cell in PMMA, designed to hold various sensors together (*chlorine, temperature, pH, flow controller, etc.*) allowing a correct flow of the sampled fluid.

Measuring cells exist for different applications and mounted in option on specific complete assemblies with a monitor BAMOPHOX 194.

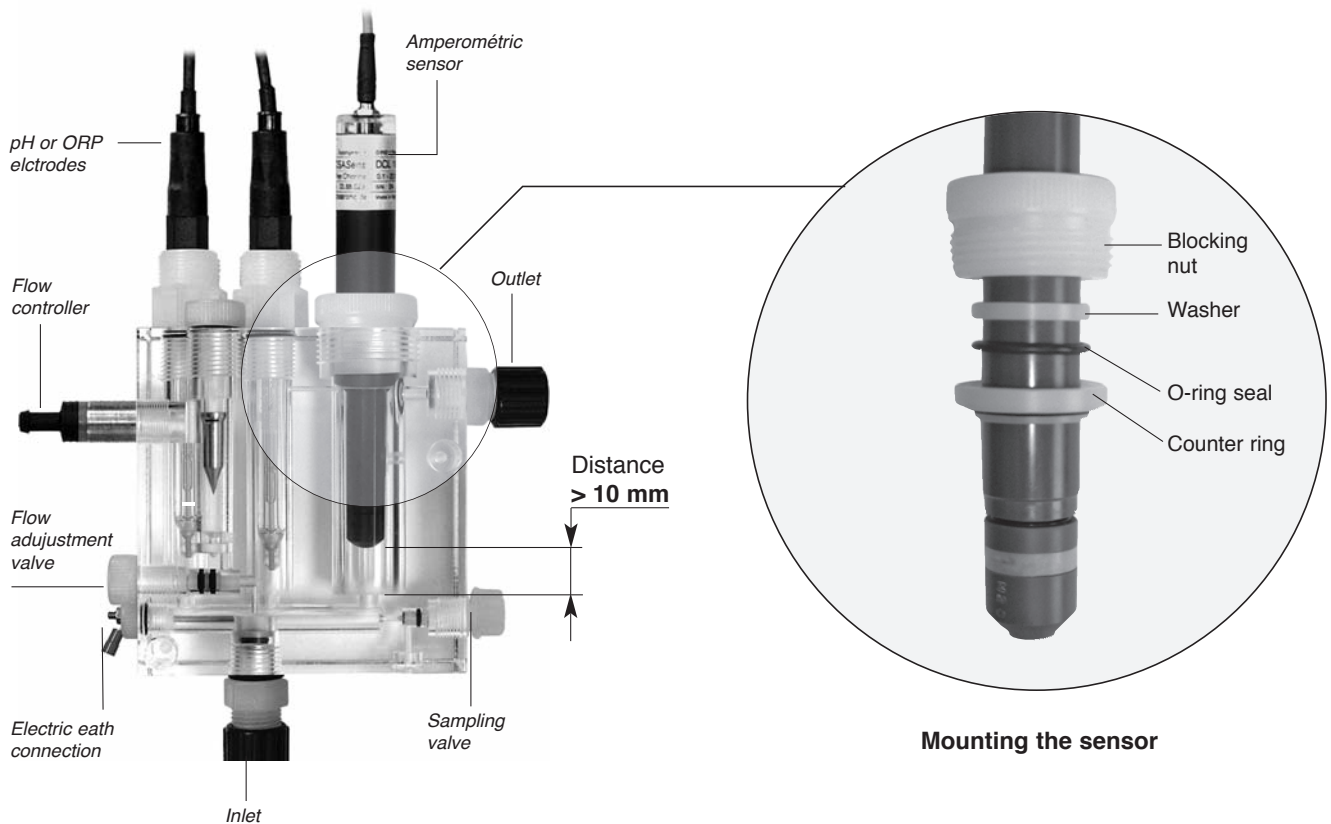

Picture A

5.1 Fitting the amperometric sensor

- To fit the sensor probe in the measuring cell, first insert on the 1" sensor housing, blocking nut, washer, O-ring seal and the counter ring as per the picture.

Screw in the blocking nut, not tightly to allow the sensor body sliding inside the measuring cell



Position the sensor: **leaving more than 10 mm distance free from the bottom** (see the picture A).

Make sure that the sensor is tightly fastened in place; otherwise it may be pressed out under pressure.

The label should be kept visible.

5.2 Electric connections

A complete system with a BAMOPHOX 194 is highly recommended.

This allows a direct measurement through the 2 wire loop, powering the sensor and protecting it against reversed polarity.

- Connect the probe with the BAMOPHOX 194 (see the specific instructions manual).
- On similar monitors, connect the sensor respecting the polarity.

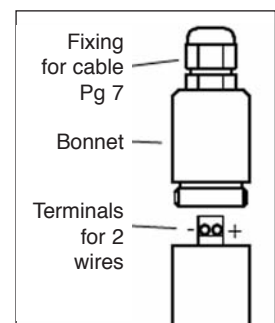

6. CALIBRATION

It is necessary to proceed to a calibration, even if sensors are already factory calibrated.

- Open slowly the valve of sample water supply. One hour of free flowing sampled water is necessary for a good polarisation, before to proceed to the slope adjustment. The adjustment should be repeated after approximately 24 hours, after a complete check up:

- The flow rate is ideally 40 L/h and constant (or constant between 30 and 100 L/h)
- Operating pressure must not exceed 0.5 bar (5 m WC)
- Operating water temperature should be between 5 and 45°C

Test the value of chlorine with the DPD method (handheld colorimeters from BAMO): DPD 1 for free chlorine, note the value. This value has to be captured as the "SLOPE" value in the BAMOPHOX 194 (see the specific instructions manual of your monitor).

Once all parameters are respected, the complete system is ready for operating.

In case of dysfunction, see the § 10 DYSFUNCTIONS



It is necessary to set up on the monitor, a timer on "injection time" of disinfectant, in order to alarm when a dysfunction occurs and the regulation is overdosing.

Take in care for all necessary procedures against or after overdosing disinfectant

7. PREVENTIVE MAINTENANCE

7.1 Weekly maintenance

A balance or checking of the probe using DPD-1 method ("free chlorine") should be performed regularly depending on utilization. Recommendation: weekly check up, if necessary more frequently.

Compare the test result with the display on the monitor. If a drift exists, proceed to a new calibration (see previous § 6)

If the drift still exists, proceed to a corrective maintenance of the sensor (see next § 8)

If there is still a defect on the measurement, contact BAMO Mesures SAS for renewing the sensor.

7.2 Electrolyte, parts replacement

It is recommended to change the electrolyte each 3 months.

The sensor end should be replaced at least once a year. It could be done more frequently according to water quality.

The diaphragm must not be kept dry; if the diaphragm is dry, it is necessary to replace it (complete sensor end).

8. SENSOR CORRECTIVE MAINTENANCE

When a preventive maintenance does not result to a correct function and/or when an adjustment of the slope is not satisfactory (unstable reading, low values displayed), proceed to the following maintenance.



a/ Set down the sensor

- Disconnect the cable
- Set down the sensor as per § 5.1 reversed operations.

b/ Set down the sensor end

- As per § 4.b reversed operations



c/ Electrode cleaning

- The electrode finger is cleaned with a clean, dry paper towel.
- With the special emery paper supplied, clean only the tip of the dry electrode (working electrode). Place the emery paper on a flat, horizontal support and rub perpendicularly the electrode tip on it, 2 or 3 times across the abrasive paper.



The brown coating of the electrode must not be sandpapered

Diaphragm cleaning

Any deposit or damages on the diaphragm induce wrong or difficult measurements; it is not warranty that a cleaning could renew properly the diaphragm.

If lime deposit occurs, you can intent a cleaning with hydrochloric acid 1% during 2 hours. Rinse it with flowing tap water before to use it.

To dismantle the sensor for an acid cleaning:

- Close the water inlet valve
- Disconnect the sensor cable (§ 5.2)
- Set down the sensor as per § 5.1 reversed operations.
- Set down the sensor end as per § 4.b reversed operations
- Plunge during 2 hours the sensor end in a 1% HCl solution
- Rinse it with flowing tap water – rinse carefully the electrode on the sensor body with tap water – do not wet the sensor connector. Do not touch the electrode with fingers.
- Dry the both, sensor end and electrode on sensor body, in a clean place without dust
- Fill in the sensor end with electrolyte as per § 4
- Set up the sensor following steps on § 4 and § 5; proceed to a new calibration as on § 6.

9. SENSOR STORAGE



A sensor, ready to use, with electrolyte, must be energized immediately (monitor powered and running on)

Note: A stored sensor, if not yet fill with electrolyte should be stored in a fresh, dry place, free from icing.

When a sensor has been set up once and should be dismantled for more than 1 day, please follow these recommendations:

- Close the water inlet valve
- Disconnect the sensor cable (§ 5.2)
- Set down the sensor as per § 5.1 reversed operations.
- Set down the sensor end as per § 8
- Rinse it with flowing tap water – rinse carefully the electrode on the sensor body with tap water –do not wet the sensor connector. Do not touch the electrode with fingers.
- Dry the both, sensor end and electrode on sensor body, in a clean place without dust
- Screw on the sensor end to the sensor body: the electrode must not touch the diaphragm
- To set up again the sensor, proceed to replace the sensor end with a new one. Clean the electrode as per § 8. c/
Set up the sensor as per § 4 and § 5, proceed then to a calibration § 6.

10. OPERATING FEATURES

- The sensor is designed for a vertical mounting, so that the flowing sampled water flush the diaphragm from the bottom.
- Be sure that the pressure is constant. The sensor affords a pressure up to 0.5 bar (5 m WC). Meanwhile operating, a pressure down will originate some gas bubbles: it does not interfere in the measurement as far as they are not blocked on the diaphragm surface (preventing disinfectant components to enter in the sensor end and causing wrong measurements).
- The sensor may suffer of strong pressure variation, as well as vibrations conducted through the sampled water.
- The ideal flow rate in the cell is 40 L/h; the minimal value is 30 L/h. This flow rate must be kept stable
- Operating temperature is from 5 to 45°C. The measuring signal is temperature compensated (built in temperature sensor), the output signal then, is free from temperature changes.
- The principle of closed cell is unnecessary zero adjustment after factory settings. The zero point itself is not dependent on changes of the flow rate, the conductivity, the temperature and the pH value.
- The diaphragm time life is commonly 1 year and may be shorter according to water quality. The probe is designed for applications with water qualities complying with the DIN 19643 standard. It is necessary not to have deposit or pollution on the diaphragm.
- Each sensor is quality control certified. The serial number allows a tracking and is necessary for any complementary information.
- Even in case of maintenance in the main pipe of the plant, the sensor should be kept running with supply from the monitor.
- The sensor must be kept in fluid and diaphragm never be dried out.
- The sensor may not work with water without free chlorine more than one day. This causes a bio-film growing on the diaphragm and would interfere on measurement quality.
- After any period without disinfectant, addition of disinfectant may be realized (in such a case, use a timer on the regulation until the end of chemical shock operation).
- Before a period of 1 day or more without disinfectant begins, it is convenient to dismount the sensor and store it cleaned and dried.
- Existent reagents, oxidants and reducers, as well as corrosion inhibitors, may interfere on the measurement.
- The measuring function is disturbed by surfactants (e.g. tensides).

11. ERRORS WHEN OPERATING

According to our knowledge, herein below are typical dysfunctions with possible corrective actions.

DYSFUNCTION	ORIGIN	CORRECTIVE ACTION
Wrong signal value	<p>Polarisation time is too short</p> <p>Broken diaphragm</p> <p>Damaged sensor end</p> <p>Interference in the signal from the fluid</p> <p>Short circuit</p> <p>Too much distance between diaphragm and the electrode</p> <p>Measurement with inappropriate reagent for the photometer or DPD test</p> <p>Deposit on the diaphragm</p> <p>Gas bubbles trapped outside the diaphragm</p> <p>Defective sensor</p> <p>No electrolyte in the sensor end</p> <p>Free chlorine over ranging</p>	<p>Repeat the calibration routine after polarisation (1 hour as a minimum § 6)</p> <p>Replace the sensor end</p> <p>Replace the sensor end</p> <p>Look at possible substances interfering. Choose a solution with help of your providers</p> <p>Find it and correct it. Change the cable if necessary</p> <p>Check and screw correctly the sensor end on the sensor body</p> <p>Check all and proceed to a new test</p> <p>Replace the sensor end with a new one</p> <p>Increase temporarily the flow rate and modify the installation if necessary</p> <p>Change the sensor</p> <p>Fill it with electrolyte</p> <p>Check all the installation, proceed to necessary modifications and repeat the calibration routine</p>
Unstable output signal	<p>Broken diaphragm</p> <p>Air bubbles in the electrolyte</p> <p>Gas bubbles trapped outside the diaphragm</p> <p>Sampled water Pressure is fluctuating</p> <p>Reference electrode is polluted</p>	<p>Replace the sensor end</p> <p>Refill the sensor end with electrolyte and check carefully before calibration</p> <p>Increase temporarily the flow rate and modify the installation if necessary</p> <p>Check all the installation, proceed to necessary modifications</p> <p>Send back the sensor to BAMO Mesures SAS for renewing</p>
4-20 mA signal output = 0	<p>Wrong polarity connection</p> <p>Broken cable</p> <p>Defective sensor</p> <p>Defective monitor</p>	<p>Correct it</p> <p>Replace it</p> <p>Send back the sensor to BAMO Mesures SAS for expertise</p> <p>Check the instrument</p>