

Instructions manual

Pocket photometers MW line



PACK CONTENT

Each photometer is supplied with:

- 2 test tubes with cap
- 1 battery 1.5 V, type AAA
- 1 instruction manual

TECHNICAL FEATURES

Range: 0.05 to 2.50 ppm
 Resolution: 0.01 ppm
 Accuracy: $\pm 0,05 \text{ ppm} \pm 3\%$ of reading (25°C)
 EMC Deviation: $\pm 0,01 \text{ ppm}$
 Light source: LED at 525 nm
 Light detector: Silicon photocell

Method: Adaptation of USEPA method 330.5.
 The reaction between chlorine and the DPD reagent causes a pink tint in the sample.

Temperature: +1...+50°C
 Humidity: 85% RH, non condensing
 Power supply: 1 battery 1.5 V type AAA
 Auto switch-off: After 2 min
 Dimensions – Mass: 87,5 x 63,7 x 35,2 mm – 65 g

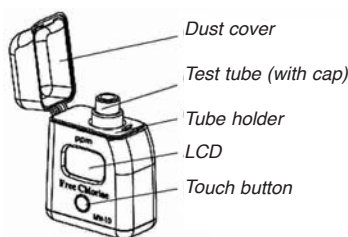

REPLACEMENT PARTS

Code	Reference	Designation
190 821	250 reagent tests, DPD1	1 pack of 250 reagent tests acc. to DPD1
190 823	250 reagent tests, Kit DPD4	1 pack of 250 reagent tests acc. to DPD1 + 1 pack of 250 reagent tests acc. to DPD3 (DPD4 obtained by DPD1 + DPD3)
190 839	Test tubes	Pack of 2 glass test tubes with cap, for photometer MW

FREE CHLORINE MEASUREMENT (MW-10)



Turn the meter ON by pressing the button. After all segments are displayed, "C.1", "Add" appears with "Press" blinking, the meter is ready.

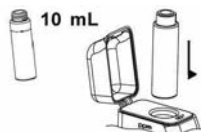

Fill the test tube with 10 mL of unreacted sample and tap it with the cap. Place it into the tube holder and close the meter cap.



Press the button. When the display shows "Add", "C.2" with "Press" blinking, zero is calibrated.



Remove the test tube, open it and add the content of one DPD1 reagent test. Replace the cap and shake gently for 20 seconds. Replace the tube into the meter.



Wait for 1 minute and then press and hold the button until the timer is displayed on the LCD.



The instrument directly displays the concentration of free chlorine in ppm. The meter automatically turns off after 10 seconds following the measurement display.

TOTAL CHLORINE MEASUREMENT (MW-11)



Turn the meter ON by pressing the button. After all segments are displayed, "C.1", "Add" appears with "Press" blinking, the meter is ready.

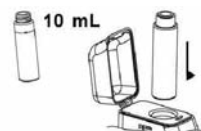

Fill the test tube with 10 mL of unreacted sample and tap it with the cap. Place it into the tube holder and close the meter cap.



Press the button. When the display shows "Add", "C.2" with "Press" blinking, zero is calibrated.



Remove the test tube, open it and add the content of one DPD1 and one DPD3 reagent tests. Replace the cap and shake gently for 20 seconds. Replace the tube into the meter.



Wait for 2 minutes and 30 seconds then press and hold the button until the timer is displayed on the LCD.



The instrument directly displays the concentration of total chlorine in ppm. The meter automatically turns off after 10 seconds following the measurement display.

BAMO MESURES

22, Rue de la Voie des Bans - Z.I. de la Gare - 95100 ARGENTEUIL
 Tél : (+33) 01 30 25 83 20 - Web : www.bamo.fr
 Fax : (+33) 01 34 10 16 05 - E-mail : info@bamo.fr

POCKET PHOTOMETERS MW line

28-04-2016

190 M1 11 D

MES

190-11/1

PRECAUTIONS FOR ACCURATE MEASUREMENTS

- The sample must not contain any particles.
- The test tube must be dry on the outside without finger prints or oil or impurities. If necessary, clean it and wipe it dry - do not use abrasive cleaners.
- Shaking with the reagent may cause gas bubbles (therefore a highest measured value). Before to place the test tube inside the tube holder, move gently the test tube until all gas bubbles disappear.
- Do not wait between end of reagent mixing and measurement in order to warranty the highest possible accuracy.
- Empty, clean, rinse and dry the test tube, as soon as possible, in order not to colour it and decrease the quality of next test.

DISPLAY OF ERROR MESSAGES

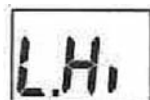

Light High: Too much transmitted light.
Check the zero operation

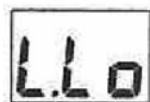

Light Low: Too weak transmitted light.
Check the zero operation

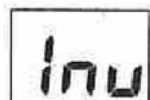

Inverted test tubes: Test tubes, on zero and test, have been exchanged.
Repeat the test operation.



Under range: Blinking display "0.00" shows a sample with less absorption than the zero test.
Repeat the zero operation.

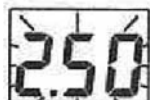

Over range: Blinking display "2.50" indicates an over range of sample.
Proceed to dilute carefully the sample and proceed to a new test.

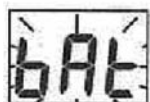

Battery low: Change the battery as soon as possible.

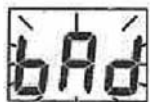

Dead battery: Change immediately the battery



With such a displayed message, all running test parameters are lost.

BATTERY LIFE TIME

- The meter automatically turns off after 2 minutes of non-use or 10 seconds after measurement display.

One fresh battery lasts for about 5000 measurements, depending on the light level. When the battery capacity is lower than 10% "bAt" appears on the LCD at start-up.

If the battery is empty and accurate measurement can't be done any more, the instrument shows "bAd" then "bAt" each for 1 second and turns off. To restart the instrument, replace the battery by a fresh one.

BATTERY REPLACEMENT

- Turn the instrument off, if not yet, by holding the button until the meter shuts off.
- Turn the instrument upside down and remove the battery cover with a screw driver.
- Remove the battery from its location and replace it by a fresh one.
- Insert the battery cover and replace the screw with a screwdriver.

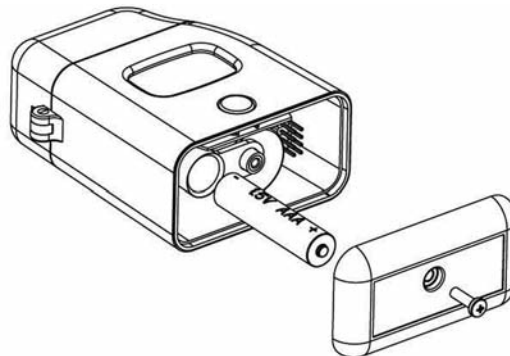

RECOMMENDATIONS

Before to use this instrument, verify the correspondence between the range to be measured and the features of the instrument.

The use of these photometers could interfere with other electronic devices.

Any modification caused by the user, or unconsidered ambient conditions, may affect the instrument.

To avoid injury, do not put the instrument in a microwave oven.

For safety reasons, do not introduce the instrument in a dangerous, explosive area.

Waste Electrical and Electronic Equipment (WEEE):

To avoid harm to the environment and natural resources, the use of appropriate recycling systems is recommended.

For any requirement, please contact **BAMO Mesures SAS**.