

# BAMOPHOX 106 E - M

## pH/mV meter

Option: 4 stages regulation processor



## INSTRUCTION MANUAL

**BAMO MESURES**

22, Rue de la Voie des Bans - Z.I. de la Gare - 95100 ARGENTEUIL  
Tél : (+33) 01 30 25 83 20 - Web : [www.bamo.fr](http://www.bamo.fr)  
Fax : (+33) 01 34 10 16 05 - E-mail : [info@bamo.fr](mailto:info@bamo.fr)

pH/mV meter  
4 stages regulation processor  
**BAMOPHOX 106**  
26-11-2008 106 M1 02 B

**MES**

106-02/1

**pH/mV meter  
4 stages regulation option**

**BAMOPHOX 106**

(Technical information and Manual for LOGGER /RS422 version are on a specific document)

**Table of contents**

	Page
1. TECHNICAL SPECIFICATIONS	3
2. DIMENSIONS	3
3. WIRING	4
4. FRONT PANEL	6
SCROLLING MENU	7
ABOUT BAMOPHOX	8
CONSULTING / MODIFYING	8
RELAY REGULATION	9
STAGES – Process regulation	9
ANALOG OUTPUT 4-20 mA FOR pH	14
ANALOG OUTPUT 4-20 mA FOR TEMPERATURE	14
TEMPERATURE PARAMETERS	14
ELECTRODE CALIBRATION	15
TESTING REGULATION MODE	16
CONFIGURING ALARM CONTACT	16
AUTO-CLEAN FUNCTION	17
LANGUAGE	17
PARAMETER CHOICE pH/mV	17

## 1. TECHNICAL FEATURES

Displayed parameters:	Measurement values pH/ORP - Configuration Menu - Temperature value
Display:	Back lighted - 2 lines of 16 alphanumeric characters ; 9,2 mm high
Indication:	LED alarms status
Configuration:	8 push buttons keyboard on front face - Keyword protected
Scales:	0 to 14 pH – pH-meter configuration / $\pm 1000$ mV ORP-meter configuration
Accuracy:	$\pm 0,03$ pH or $\pm 3$ mV
Input impedance:	$>10^{13} \Omega$
Probe input:	Coaxial connector, code 9054
Temperature compensation:	Automatic with an input for a 3 wires Pt 100 Ohm/0°C range, 0...100°C Manually from 0...100°C
Relay outputs:	4 closing contacts (Silver alloy), voltage free S1 / Regulation Low Bandwidth S2 / Regulation High Bandwidth S3 / Contact "End of process" S4 / Alarm contact – disabled or set up simultaneously for: <ul style="list-style-type: none"> <li>- Too long injection</li> <li>- Temperature out of range:</li> <li>- pH&gt;14 or open loop</li> <li>- Pt 100 <math>\Omega</math> dysfunction or probe cleaning function</li> </ul>
Contact:	Initial resistance 100 m $\Omega$ as a maximum (voltage drop 6 V DC 1 A) Rated at 831 V AC / 3 A / 277 V AC ; 90 W / 3 A / 30 V DC Switching capacity (minimum) 100 mA, 5 V DC (depending of switching frequency, ambient conditions, accuracy) Mechanical life time (minimum) 5 x 10 <sup>6</sup> operations (180 commutation/min) Electrical life time (minimum) 2 x 10 <sup>5</sup> (20 comm./min) [3 A, 125 V AC], [3 A, 30 V DC] and 10 <sup>5</sup> (evaluated charge) for 3 A, 125 V AC
Calibration sequence:	Regulation on standby, relay outputs inhibited, analog outputs stand on last values
Self-cleaning program:	Frequency and duration settings, with regulation inhibited and analog outputs standing on last values
Measurement output:	0/4-20 mA (maxi 600 $\Omega$ ) proportional to measurement, galvanic insulated
Temperature output:	0/4-20 mA (max 600 $\Omega$ ), scaling 0...100°C, galvanic insulated
Program tsetting	Simulation through the menu on relays outputs.
Main power supply:	230 V AC / 50-60 Hz [other on request] - Consumption 10 VA
Models:	Panel mounting, IP65, 72 x144 mm, connections on screw terminal IP40 Idem DIN Rail mounting, only for blind monitor Wall mounting, IP65, cable glands, connections on screw terminal

### OPTION (RS 422 + Logger)

Communication:	RS422 output, J-BUS link, binary slave mode, 2400 to 9600 bauds
Data Logger:	Cycle average measurement record, with a programmable period, 150000 records maxi on MMC (multi media card) / External driver necessary

## 2. DIMENSIONS

**Extension terminal:**  
identical to the panel  
or wall mounting

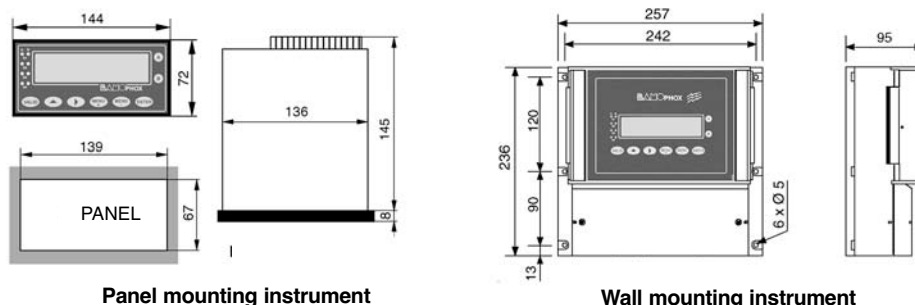

### 3. WIRING

#### PANEL MOUNTING

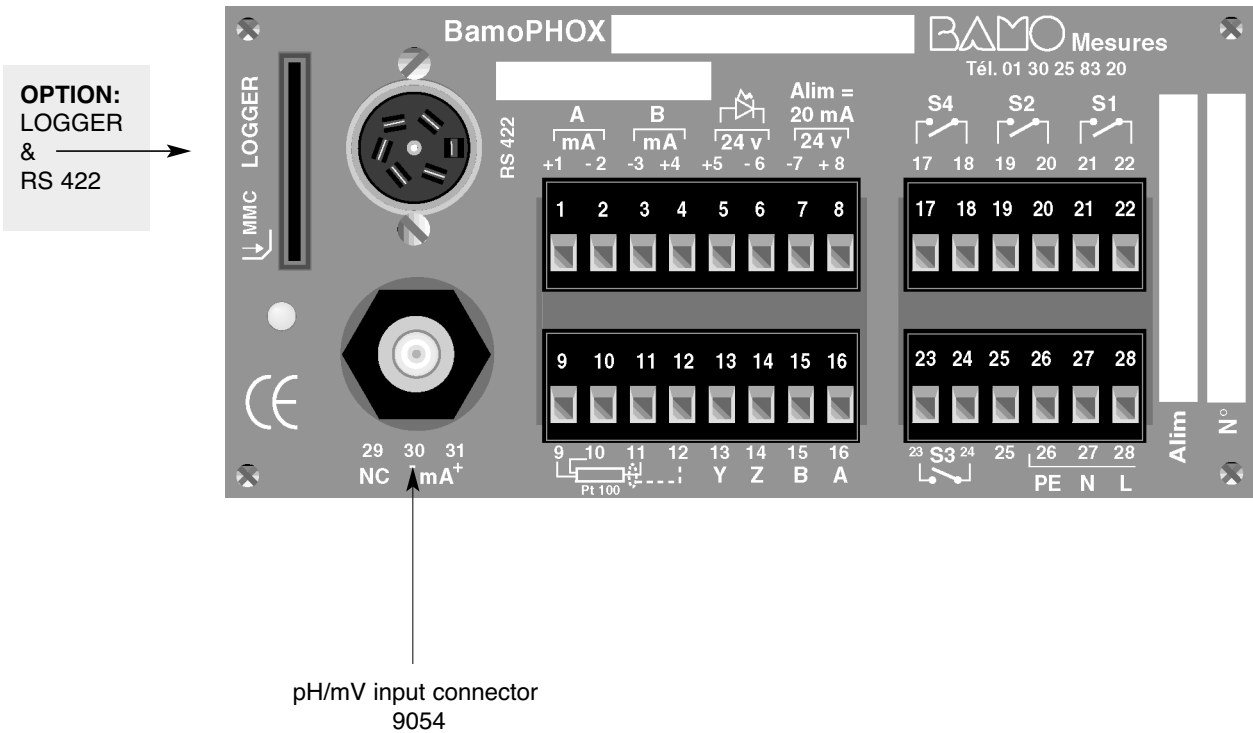

#### WALL MOUNTING

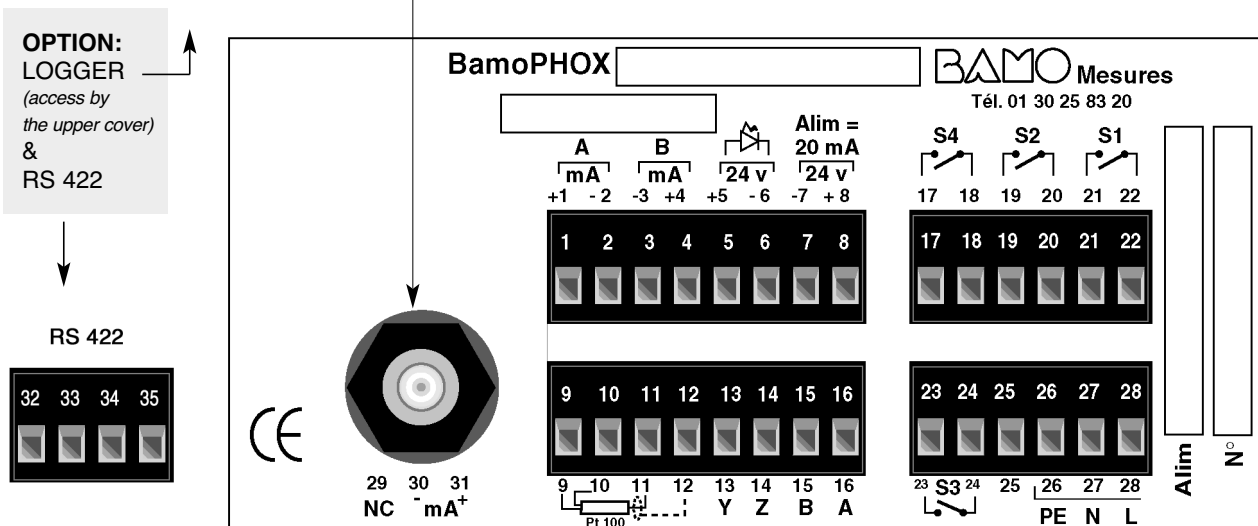

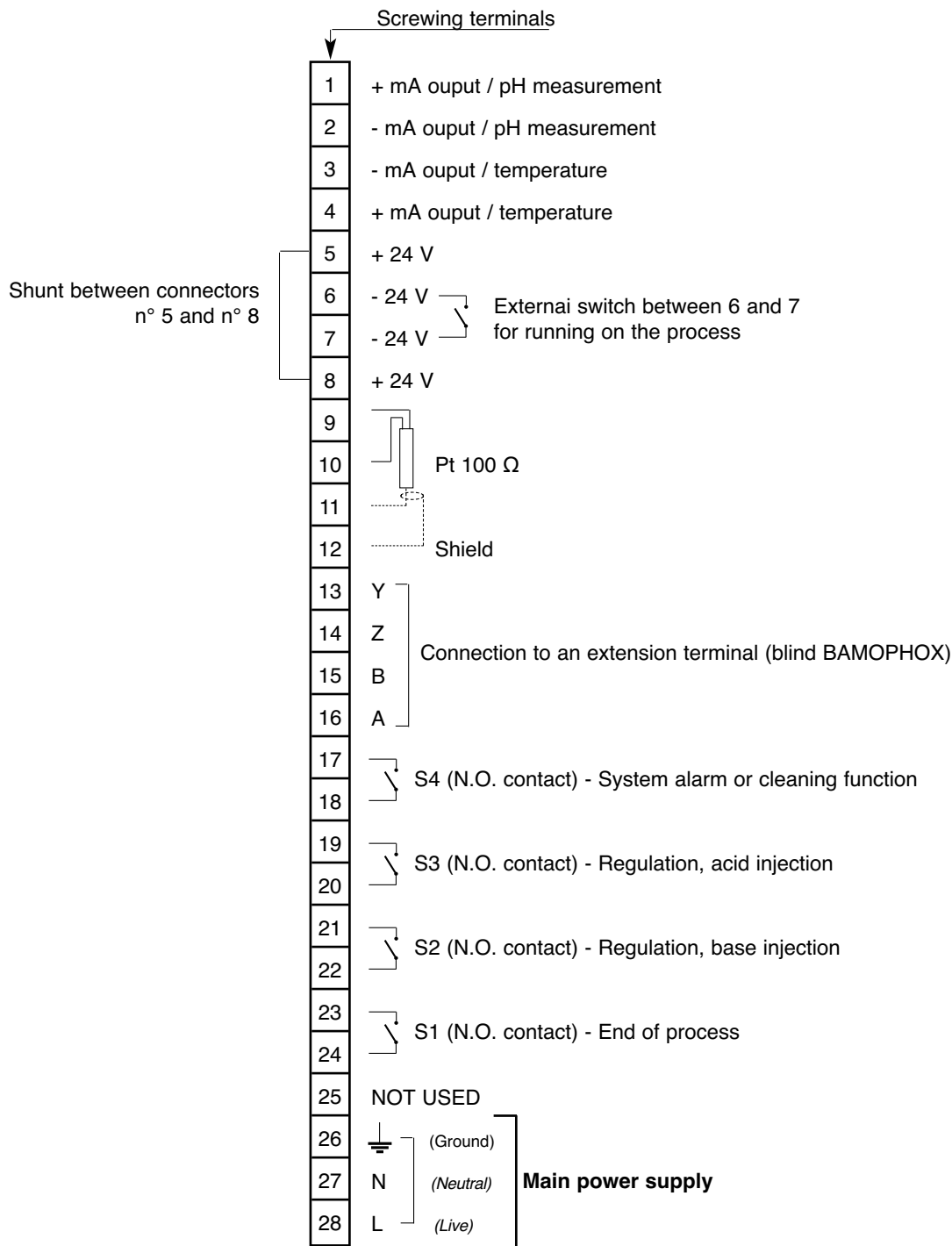

### Wiring from wall or panel mounting BAMOPHOX to an Extension terminal BAMOPHOX

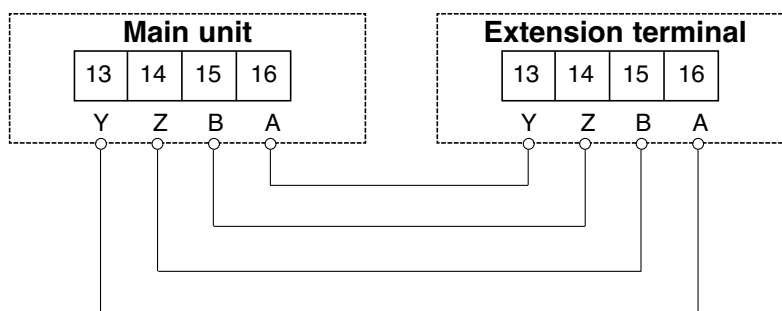

- Maximum length cable  
500 m

- Wire specifications:  
Mains cable or 4 wires shielded cable  
 $\geq 0,25 \text{ mm}^2$  cross section

## 4. FRONT PANEL

### S1, S2, S3, and S4

indicate relays status:

LED lighting = contact ON  
LED OFF = contact OFF  
LED flashing = Timer in use

2 lines /16 alphanumeric characters  
9.22 mm high - Back lighted

### Key "A"

To display the parameters of upper line.  
(main BAMOPHOX)

### Key "B"

To display the parameters of lower line.  
(Extension blind BAMOPHOX)



### "VALID" key

To save the parameters on EPROM  
when it asks:

### VALIDATION ?

Caution, when you press this key,  
all parameters are saved.  
(previous data programming  
will be overwritten).

If you are not sure of any modification,  
do not press the VALID key,

To change parameters of data capture:

Numéric input increase the  
flashing digit (loop 0 after 9).

Reverse the choice Yes / No,  
Up/Down, 0-20 mA / 4-20 mA etc.

To go to the next display or to change a value.

### "ENTER" key

To change the step displayed menu.  
At the last step, it comes back to the  
first line.

### "MENU -" key

To move the cursor during configuration.  
At the last digit, comes back on the first one.

### "MENU +" key

To go to the next menu.

Pushing simultaneously both keys

"MENU +" and "ENTER"  
allows a fast return to measurement display.

**On measurement mode,** by pressing on "ENTER" key, the regulation status is displayed.

## SCROLLING MENU

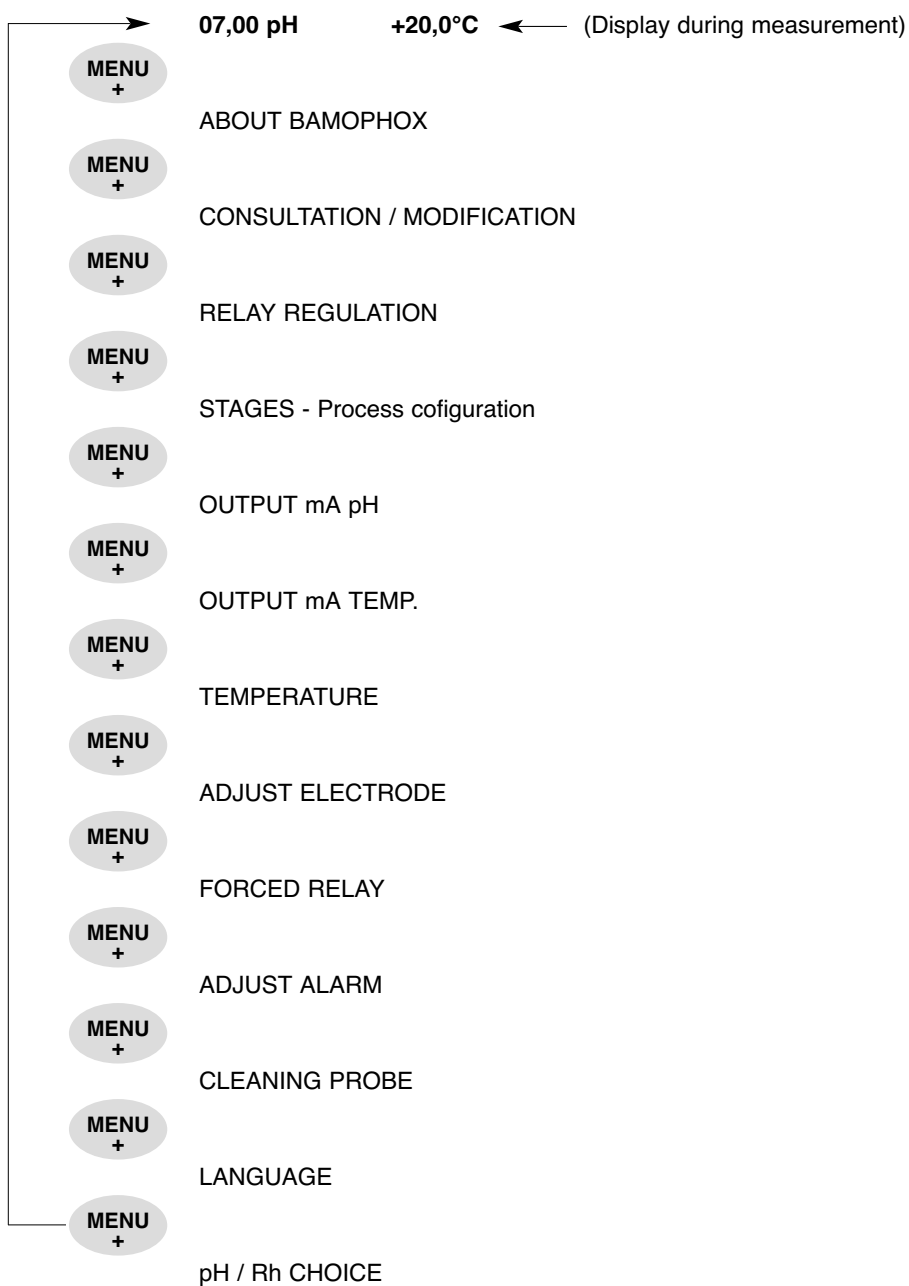

## ABOUT Bamophox

ENTER

ABOUT BAMOPHOX

ENTER

VERSION 3,00

ENTER

SERIAL N°

ENTER

2116801

## CONSULTATION / MODIFICATION

CONSULTATION



MODIFICATION

ENTER

CODE ? 0000

ENTER

CODE ? 6801

ENTER

TIME : 30 mn

MENU

+



Last 4 digits (of serial number) are the key code to access the MODIFICATION menu.

When wrong code is entered, a message "**ERROR**" appears during 3 seconds.

After 30 minutes, the display returns automatically to the measurement mode.

**From this mode MODIFICATION it is easy to return back to measurement for testing the relay outputs and regulation mode.**

Once in modification mode, reach measurement display and press ENTER

ENTER

FORCED MEASURE

ENTER

0,000 pH +20°C



(one digit is flashing) Modify the value. Immediately the instrument acts within the configuration (thresholds, regulation, analog outputs ...).



## RELAY REGULATION

MENU +

STAGES - Process configuration

ENTER

REGUL ON/OFF



Relay regulation mode

ENTER

SET VAL. 07,00 pH



Set point: As soon as the process is launched, the values of set points C1, C2, C3 and C4 from process configuration are considered for each stage.

ENTER

T. CYCLE 0000 SEC



Cycle time

ENTER

HIGH PB 05,00 pH



Highest limit for proportional bandwidth

ENTER

LOW PB 05,00 pH



Lowest limit for proportional bandwidth

ENTER

HIGH DZ 00,50 pH



Highest value for dead zone

ENTER

LOW DZ 00,00 pH



Lowest value for dead zone

VALID

SAVING ?

This menu, RELAY REGULATION, allows a configuration in accordance with the response time of the system: tank + pumps + sensors + valves + pipes + agitators... etc.

You may consider the delay to have a measurement as a good image as of the real value due to the mixing of fluids, in progress during the operation.

The set point value will be automatically set up at the successive values of C1, C2, C3 and C4 saved in the next menu "STAGES".

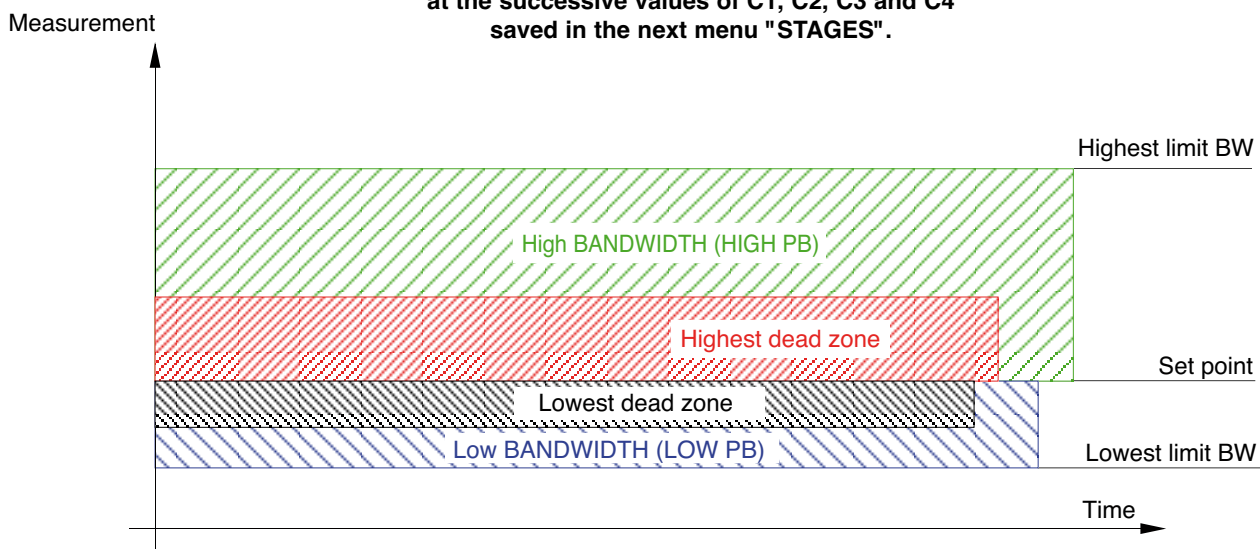

**Caution:** On S1 (base injection) you set up the lowest value for proportional bandwidth and, respectively on S2 (acid injection), the highest value.

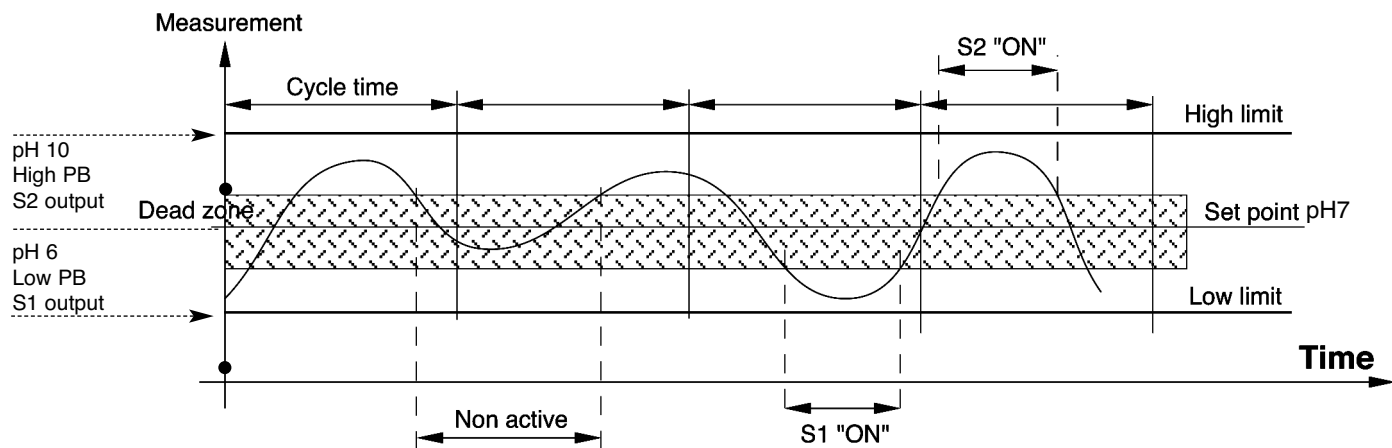

**CAUTION:** The bandwidth limits are respectively  
 - Low proportional bandwidth for relay 1  
 - High proportional bandwidth for relay 2

**You may not invert them**

### Example: Process regulation with acid and base injections

With process configuration:

- Set point: pH 7
- High dead zone: 0,3 pH between 7 and 7,3 pH
- Low dead zone : 0,7 pH between 6,3 and 7 pH
- High Bandwidth: 3 pH (Limit of pH 10 as a maximum)
- Low Bandwidth: 1 pH (Limit of pH 6 as a minimum)

- Over the highest limit (from pH 10 to 14), S2 is "ON": permanent injection

- Under the lowest limit (from pH 6 to 0), S1 is "ON": permanent injection

- Inside the dead zone (from pH 6,3 to 7,3), S1 and S2 are "OFF"

- If the measurement value is between the dead zone and the highest limit (from pH 7,3 to 10) or between the dead zone and the lowest limit (from pH 6,3 to 6), the contact S1 or S2 are "ON" only for a time proportional to the step between measurement and desired value.

$$\text{Closing contact time} = \frac{\text{Cycle time} \times (\text{Measurement} - \text{Set point})}{\text{Proportional bandwidth}}$$

**Caution:** The minimum closing time of a relay is 1 second  
 If the measurement M=7,8 when the cycle time is 10 second,

the closing contact time is:  $\frac{10 \times (7,8-7)}{3} = 2,66 \approx 3 \text{ s}$

**NOTE:** The cycle time is measured and will depend of the installation and injected volumes

→ **STAGES - Process regulation**

MENU  
+

→ Output mA

ENTER

REGULATION **ON/OFF**

ENTER

SET-UP. 1 **00,00** pH



Set point C1

ENTER

LENGTH 1 **0000** mn



Wait 1, in minutes

ENTER

VARIATION 1 **00,00** pH



Variation on C1 - limits within process step is valid

ENTER

TMAX 1 **0000** mn



Tx1, maximal duration before to start miscounting, stage 1

ENTER

SET-UP. 2 **00,00** pH



Set point C2

ENTER

LENGTH 2 **0000** mn



Wait 2, in minutes

ENTER

VARIATION 2 **00,00** pH



Variation on C2 - limits within process step is valid

ENTER

TMAX 2 **0000** mn



Tx2, maximal duration before to start miscounting, stage 1

ENTER

SET-UP. 3 **00,00** pH



Set point C3

ENTER

LENGTH 3 **0000** mn



Wait 3, in minutes

ENTER

VARIATION 3 **00,00** pH



Variation on C3 - limits within process step is valid

ENTER

TMAX 3 **0000** mn



Tx3, maximal duration before to start miscounting, stage 1

ENTER

SET-UP. 4 **00,00** pH



Set point C4

ENTER

LENGTH 4 **0000** mn



Wait 4, in minutes

ENTER

VARIATION 4 **00,00** pH



Variation on C4 - limits within process step is valid

ENTER

TMAX 4 **0000** mn



Tx4, maximal duration before to start miscounting, stage 1

VALID

SAVING ?

**NOTES:**

- A free potential switch (external) starts the process.
- When this contact is maintained closed, it does not allow a new processing sequence.
- On the switch loop, it is possible to add in line, other safety controls such as level switches.

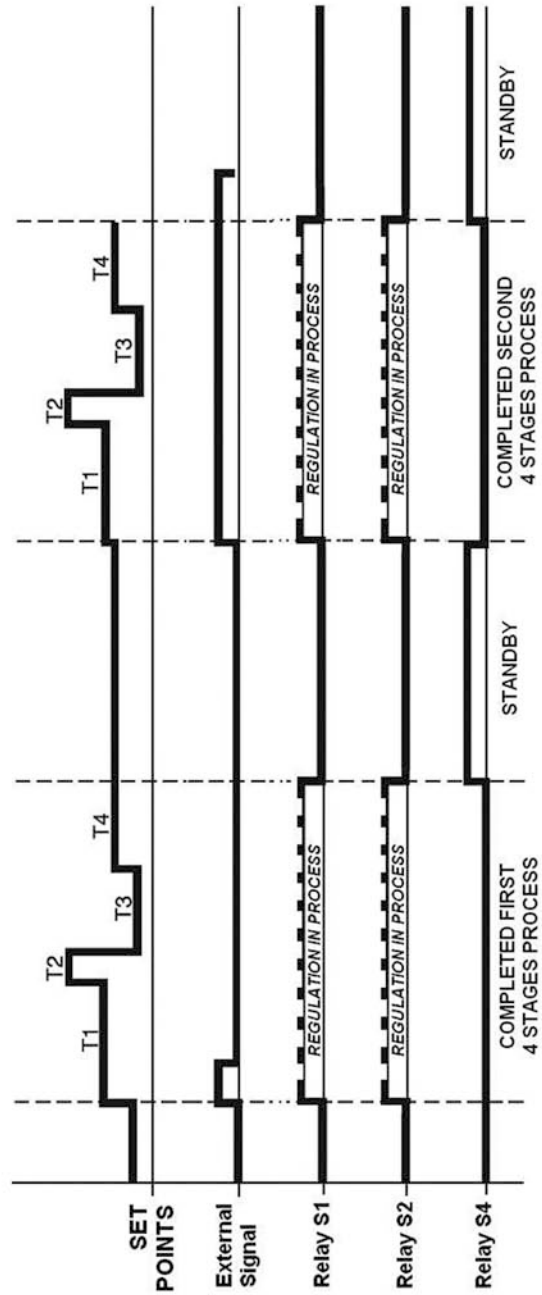

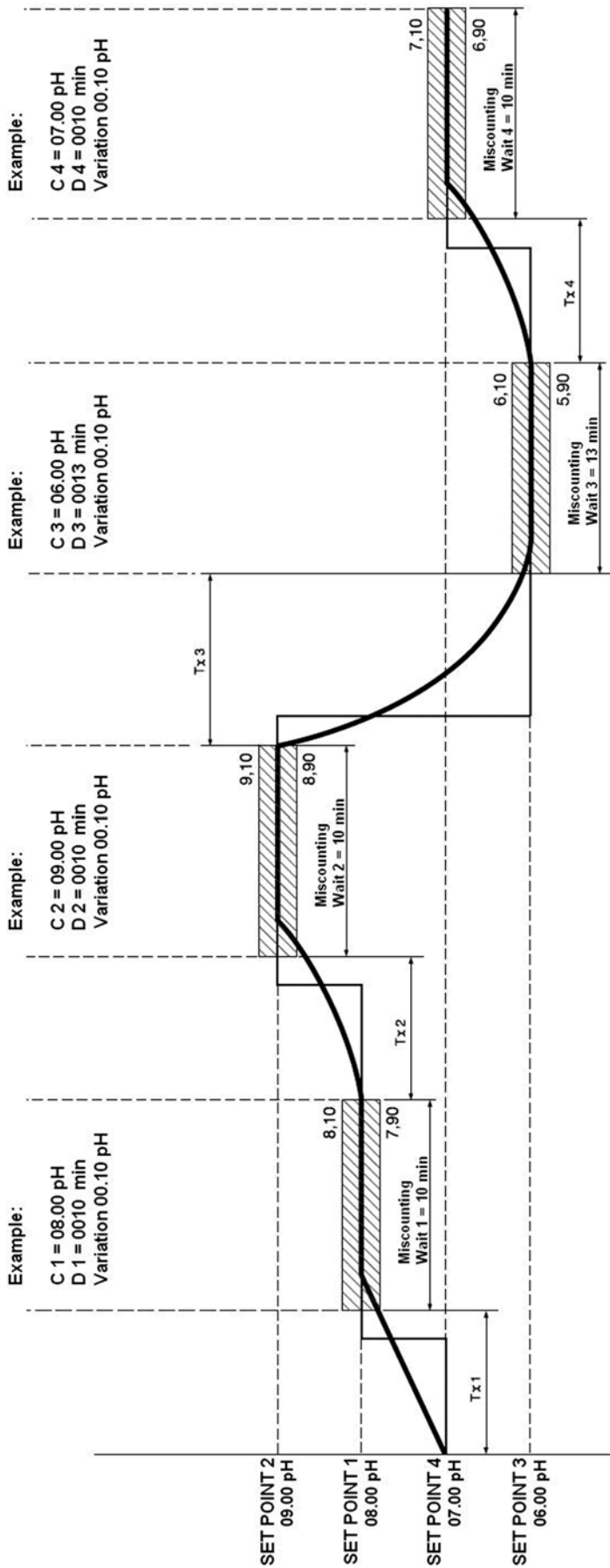

If an alarm condition occurs;  
(when Tx > T max)  lighting LED

Available information on the LCD display by pressing "ENTER"

Process not in operation: STOP : 000 mn

Process in operation: Stage n° and time before ending 1 : 0002 mn  
when pH value is out of bandwidth ! 1 : 0010 mn

  is lighting until the alarm condition disappears.

There is no need to reset the alarm status; the process runs after the alarm condition disappears.

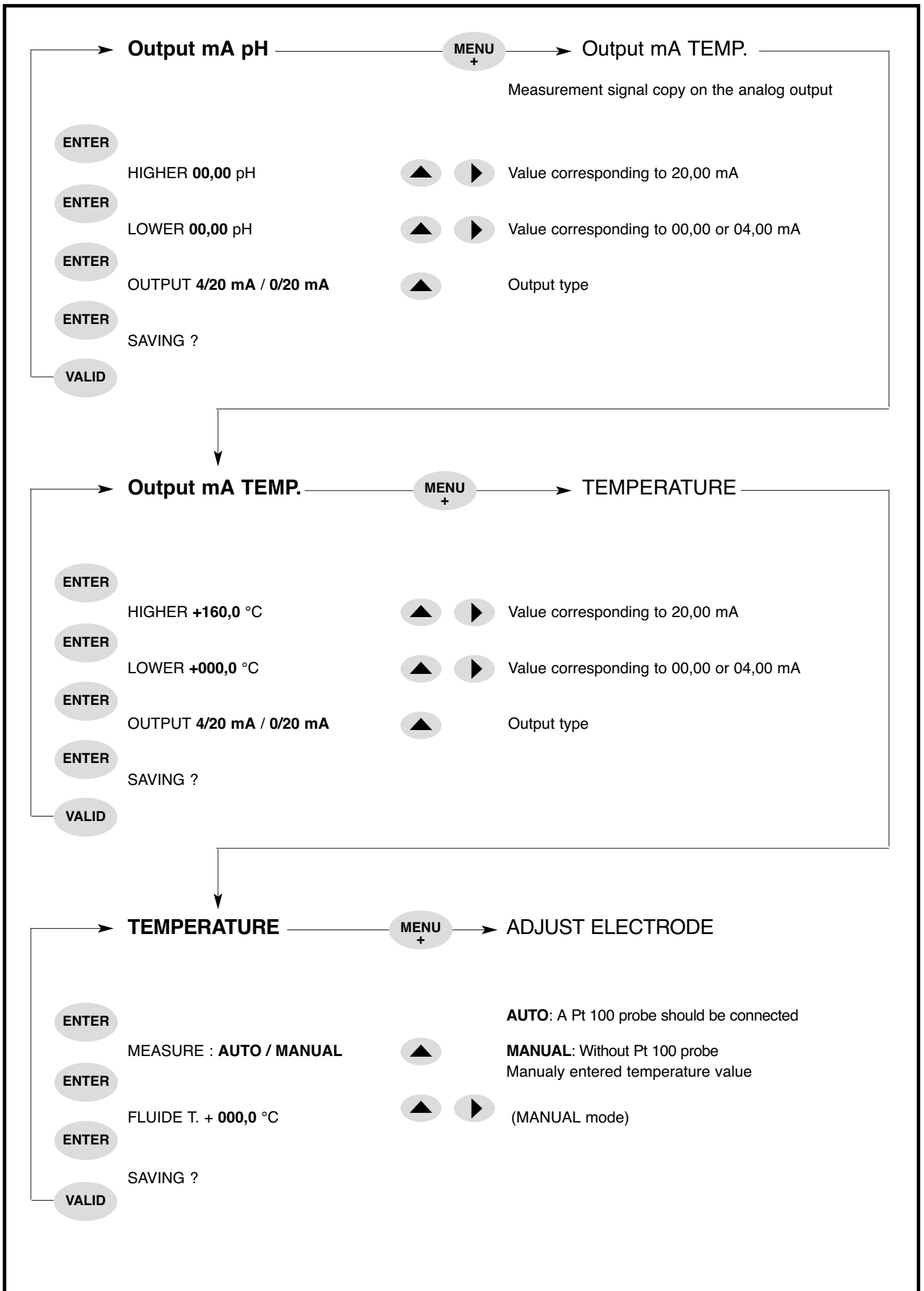

→ **ADJUST ELECTRODE**

MENU  
+

→ **FORCED RELAY**

ENTER

STANDARD 7,00 pH

**CAUTION: Set up the instrument on MANUAL mode at 20°C.**

Immerge the electrode in the buffer pH 07,00

ENTER

ASYM. +00,00 pH

When display stabilizes, press ENTER to fix up the 07,00 pH (electrical zero)

If the "ASYM" value is too high, an "ERROR" message appears. So you may check all the connections, cable and buffer type solution.

If the "ERROR" message persists, please replace the electrode with a new one.

ENTER

STAND. 00,00 pH



When pH 07,00 is fixed up, rinse the electrode with tap water (Never use paper or tissue). Enter the pH value of the next buffer (04,00 or 10,00) (it would be better to choose an acidic buffer for an acidic process)

ENTER

SLOPE 000,0 %

Sensor gain is displayed.

If it is too weak (< 70%) an "ERROR" message appears. So, check the buffer solution. if persisting, please replace. If the "ERROR" message still appears, replace the electrode.

ENTER

DELAY 0000 Sec



Set up the delay before to start back the regulation mode once the calibration is ending ("SAVING")

ENTER

SAVING ?

VALID

**CAUTION: If a PT100 probe is connected, reset the default status**

## FORCED RELAY

MENU  
+

## ADJUST ALARM

ENTER

ALARM 1 ON/OFF



ENTER

ALARM 2 ON/OFF



ENTER

ALARM 3 ON/OFF



ENTER

ALARM 4 ON/OFF



VALID

} Diagnostic mode to test the threshold configurations

## ADJUST ALARM

MENU  
+

## CLEANING PROBE

ENTER

WITH / WITHOUT ALARM



ENTER

TIME. S1 0000 Sec



Overtiming on S1 closed contact  
(maximum time for active relay)

ENTER

TIME. S2 0000 Sec



Overtiming on S2 closed contact  
(maximum time for active relay)

ENTER

SAVING ?

VALID

This mode allows to detect a malfunction on S1 and S2 contacts ; an overtime contact could be set up.



**CLEANING PROBE**

MENU +

**LANGUAGE**

With this mode,  
the alarms on S1 and S2  
are disabled.

**(Contact S4)**

In order to protect the regulation, all measurements are on stand-by during the cleaning process (plus a delay before to restart the operating mode).

ENTER

**ALARM MODE**

This message informs that regulation mode is "ON". Switch off this mode in the menu "ADJUST ALARM" (previous menu).

ENTER

**CLEANING YES / NO**

ENTER

PERIOD 0000 Sec



Set up the time after wich a cleaning sequence will begin

ENTER

TIME 0000 Sec



Cleaning time

ENTER

DELAY 0000 Sec



Delay after cleaning, before to restart the regulation mode

ENTER

SAVING ?



VALID

**LANGUAGE**

MENU +

**CHOICE OF THE PARAMETER**

ENTER

ENGLISH / ITALIAN / GERMAN / FRENCH



ENTER

SAVING ?

VALID

**CHOICE OF THE PARAMETER**

MENU +

**Back to measurement mode**

ENTER

pH / Rh - METRE



ENTER

SAVING ?

VALID