

VP3V - INOX

Pneumatically actuated 3-way ball valves



INSTRUCTIONS MANUAL

BAMO MESURES

22, Rue de la Voie des Bans - Z.I. de la Gare - 95100 ARGENTEUIL

Tél : (+33) 01 30 25 83 20 - Web : www.bamo.fr

Fax : (+33) 01 34 10 16 05 - E-mail : info@bamo.fr

**Pneumatically actuated
3-way ball valves
VP3V - INOX**

12-11-2013

1013 M1 02 B

METAL

1013-02/1

DESCRIPTION

Pneumatic actuators are designed for controlling quarter turn valves. For any other purpose, please report to us before start up; we may not be responsible of troubles due to other applications.

1. Fitting on the pipe line

1.1. Precautions

Before fitting the valve, it is necessary to verify the chemical compatibility between all the elements (fluid vs. body, seals, seating joints).

1.2. Assembly

Respect common precautions for the assembly of all elements together.
All parts should correspond in dimensions, pressure & temperature limits.

2. Pneumatic actuators connection

2.1. Precautions

Fitting, connections, initial start-up and maintenance operations must be done by trained technicians.
All European and local rules for pneumatic devices and systems must be respected.

2.2. Connecting the actuator

A pilot valve certified for our actuators would be preferable to any other devices:

- Pilot valve: 3/2-way solenoid valve (single effect)
- Pilot valve: 5/2-way solenoid valve (double effect)

Compressed air supply through G 1/4" connection: acc. NAMUR specifications.
Maximal pressure is 6 bar.

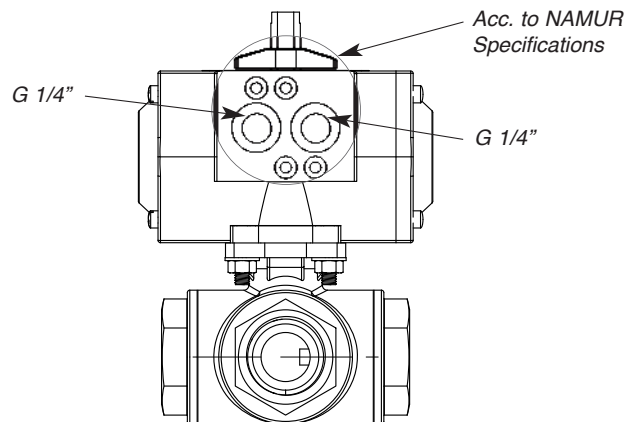

3. Assistance with manual operating

- Exhaust the compressed air before to intent a manual operating
- Turn on the spindle with an appropriate tool.



4. Specifications of 3 ways ball valve

3 ways valves L shape

"L1" fonction: distribution

1 input, 2 output

Start position (0°)

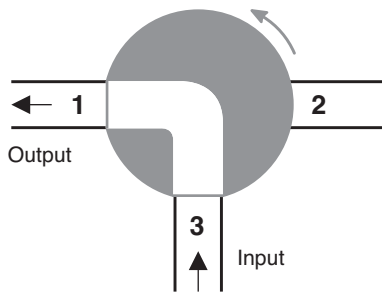

90° Rotation
(clockwise or anticlockwise)

End position (90°)

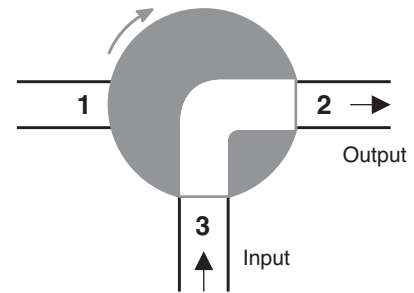

3 ways valves T shape

"T1" fonction: Mixing

2 input, 1 output

Start position (0°)

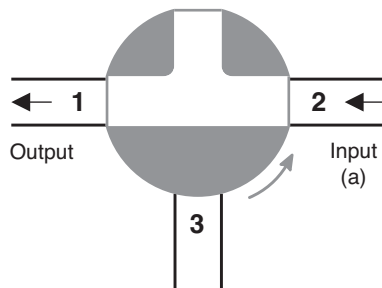

90° Rotation
(clockwise or anticlockwise)

End position (90°)

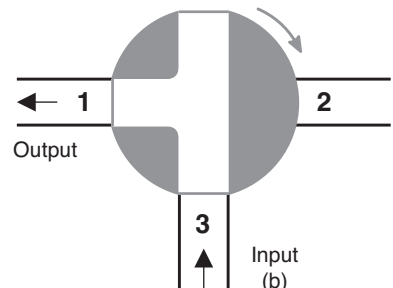

3 ways valves T shape

"T2" fonction: switching

1 input, 2 output

Start position (0°)

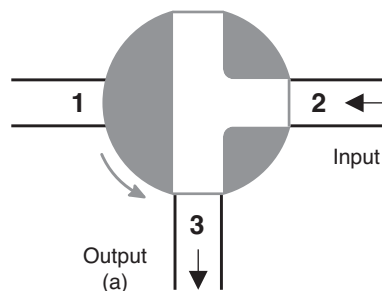

90° Rotation
(clockwise or anticlockwise)

End position (90°)

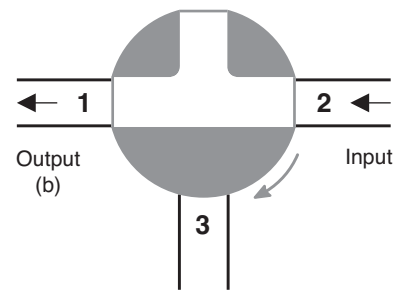

3 ways valves T shape

"T3" fonction: switching

Mode 1: 1 input, 2 output

Mode 2: 1 input, 1 output

Start position (0°)

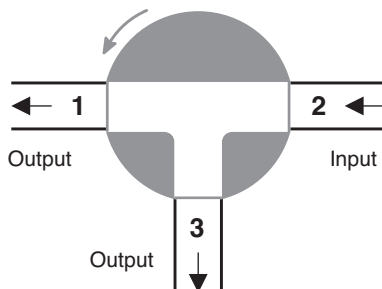

90° Rotation
(clockwise or anticlockwise)

End position (90°)

